

TOSHIBA

OWNER'S MANUAL

3LCD DATA PROJECTOR

TLP-T700	(XGA / High Brightness / With PC Card Slot)
TLP-T701	(XGA / High Brightness / With PC Card Slot & Document Camera)
TLP-T600	(XGA / High Brightness)
TLP-T601	(XGA / High Brightness / With Document Camera)
TLP-T500	(XGA / With PC Card Slot)
TLP-T501	(XGA / With PC Card Slot & Document Camera)
TLP-T400	(XGA)
TLP-T401	(XGA / With Document Camera)
TLP-S200	(SVGA)
TLP-S201	(SVGA / With Document Camera)

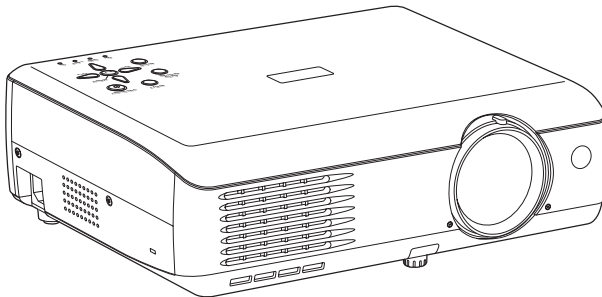

TLP-T700 / TLP-T600 / TLP-T500 / TLP-T400 / TLP-S200

Before Using

Preparations

Operations

Maintenance

Others

SAFETY PRECAUTIONS

<p>WARNING: BEFORE OPERATING PLEASE READ OWNER'S MANUAL. DO NOT REMOVE SCREWS EXCEPT LAMP COVER SCREWS. DO NOT BLOCK VENTING OPENINGS.</p>	<p>THIS DEVICE COMPLIES WITH PART 15 OF THE FCC RULES. OPERATING THIS DEVICE TO THE LIMITS OF THESE RULES IS INTENDED TO PROTECT YOU FROM UNDESIRABLE INTERFERENCE TO OTHERS. THIS DEVICE DOES NOT GUARANTEE INTERFERENCE PROTECTION.</p>
<p>AVIS: Veuillez lire le mode d'emploi avant d'utiliser. NE PAS RETIRER LES VIS À L'EXCEPTION DES VIS DU COUVERCLE DE LA LAMPÉ. NE BOCUZEZ PAS LES ORIFICES DE VENTILATION.</p>	<p>WARNING: VOR DEM EINSATZ DIE BEDIENUNGSANLEITUNG LESEN. KEINE SCHRAUBEN AUSSER DEN LAMPENDECKELSCHRAUBEN ENTFERNEN. LÜFTUNGSPÖFFNUNGEN NICHT BLOCHEHEN.</p>
<p>警告: ご使用前に、取扱説明書をお読みください。 ランプカバー以外のネジを取り外さないでください。 通気孔をふさがしないでください。</p>	<p>警告: ご使用前、取扱説明書を使用説明書、追加保証台帳(台、付属品説明書)追加保証通気孔以内内部温度上昇導致故障火災。 23553839</p>



The lightning flash with arrowhead symbol, within an equilateral triangle, is intended to alert the user to the presence of uninsulated "dangerous voltage" within the product's enclosure that may be of sufficient magnitude to constitute a risk of electric shock to persons.



The exclamation point within an equilateral triangle is intended to alert the user to the presence of important operating and maintenance (servicing) instructions in the literature accompanying the appliance.

WARNING: TO REDUCE THE RISK OF FIRE OR ELECTRIC SHOCK, DO NOT EXPOSE THIS APPLIANCE TO RAIN OR MOISTURE. DANGEROUS HIGH VOLTAGES ARE PRESENT INSIDE THE ENCLOSURE. DO NOT OPEN THE CABINET. REFER SERVICING TO QUALIFIED PERSONNEL ONLY.

FCC Radio Frequency Interference Statement

Note: This equipment has been tested and found to comply with the limits for a Class A digital device, pursuant to part 15 of the FCC Rules. These limits are designed to provide reasonable protection against harmful interference when the equipment is operated in a commercial environment. This equipment generates, uses, and can radiates radio frequency energy and, if not installed and used in accordance with the instruction manual, may cause harmful interference to radio communications. Operation of this equipment in a residential area is likely to cause harmful interference in which case the user will be required to correct the interference at his own expense.

WARNING: Changes or modifications made to this equipment, not expressly approved by **USA only** Toshiba, or parties authorized by Toshiba, could void the user's authority to operate the equipment.

Notice: This Class A digital apparatus complies with Canadian ICES-003. Cet appareil numérique de la classe A est conforme à la norme NMB-003 du Canada. **CANADA only**

WARNING: This is a Class A product. In a domestic environment this product may cause radio interference in which case the user may be required to take adequate measures.

CAUTION: Laser beam is emitted when the laser button of the remote control is pressed. Do not look from the front of the remote control. Do not face toward a person or to a mirror.

IMPORTANT SAFETY INSTRUCTIONS

CAUTION: PLEASE READ AND OBSERVE ALL WARNINGS AND INSTRUCTIONS GIVEN IN THIS OWNER'S MANUAL AND THOSE MARKED ON THE UNIT. RETAIN THIS BOOKLET FOR FUTURE REFERENCE.

This set has been designed and manufactured to assure personal safety. Improper use can result in electric shock or fire hazard. The safeguards incorporated in this unit will protect you if you observe the following procedures for installation, use and servicing. This unit is fully transistorized and does not contain any parts that can be repaired by the user.

DO NOT REMOVE THE CABINET COVER, OR YOU MAY BE EXPOSED TO DANGEROUS VOLTAGE. REFER SERVICING TO QUALIFIED SERVICE PERSONNEL ONLY.

1. Read Owner's Manual

After unpacking this product, read the owner's manual carefully, and follow all the operating and other instructions.

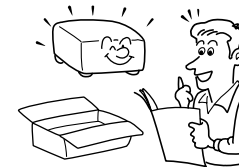

2. Power Sources

This product should be operated only from the type of power source indicated on the marking label. If you are not sure of the type of power supply to your home, consult your product dealer or local power company. For products intended to operate from battery power, or other sources, refer to the operating instructions.



3. Source of Light

Do not look into the lens while the lamp is on. The strong light from the lamp may cause damage to your eyes or sight.



4. Ventilation

Openings in the cabinet are provided for ventilation and to ensure reliable operation of the product and to protect it from overheating, and these openings must not be blocked or covered. The openings should never be blocked by placing the product on a bed, sofa, rug or other similar surface. This product should not be placed in a built-in installation such as a bookcase or rack unless proper ventilation is provided or the manufacturer's instructions have been adhered to.



IMPORTANT SAFETY INSTRUCTIONS (Continued)

5. Heat

The product should be situated away from heat sources such as radiators, heat registers, stoves, or other products (including amplifiers) that produce heat.

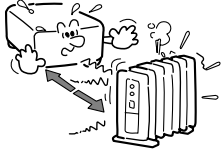

6. Water and Moisture

Do not use this product near water. - for example, near a bath tub, wash bowl, kitchen sink, or laundry tub; in a wet basement; or near a swimming pool and the like.

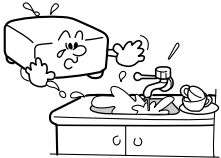

7. Cleaning

Unplug this product from the wall outlet before cleaning. Do not use liquid cleaners or aerosol cleaners. Use a soft cloth for cleaning.

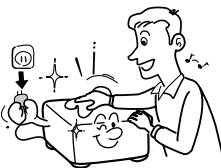

8. Power-Cord Protection

Power-supply cords should be routed so that they are not likely to be walked on or pinched by items placed upon or against them, paying particular attention to cords at plugs, convenience receptacles, and the point where they exit from the product.



9. Overloading

Do not overload wall outlets; extension cords, or integral convenience receptacles as this can result in a risk of fire or electric shock.



10. Lightning storms

For added protection for this product during storm, or when it is left unattended and unused for long periods of time, unplug it from the wall outlet. This will prevent damage to the product due to lightning and power-line surges.



11. Object and Liquid Entry

Never push objects of any kind into this product through openings as they may touch dangerous voltage points or short-out parts that could result in a fire or electric shock. Never spill liquid of any kind on the product.



12. Do not place the product vertically

Do not use the product in the upright position to project the pictures at the ceiling, or any other vertical positions. It may fall down and dangerous.

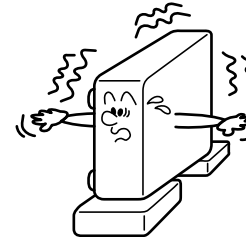

13. Stack Inhibited

Do not stack other equipment on this product or do not place this product on the other equipment. Top and bottom plates of this product develops heat and may give some undesirable damage to other unit.



14. Attachments

Do not use attachments not recommended by the product manufacturer as they may cause hazards.

15. Accessories

Do not place this product on an unstable cart, stand, tripod, bracket, or table. The product may fall, causing serious injury to a child or adult, and serious damage to the product. Use only with a cart, stand, tripod, bracket, or table recommended by the manufacturer, or sold with the product. Any mounting of the product should follow the manufacturer's instructions, and should use a mounting accessory recommended by the manufacturer. A product and cart combination should be moved with care. Quick stops, excessive force, and uneven surfaces may cause the product and cart combination to overturn.



IMPORTANT SAFETY INSTRUCTIONS (Continued)

16. Damage Requiring Service

Unplug this product from the wall outlet and refer servicing to qualified service personnel under the following conditions:

- a) When the power-supply cord or plug is damaged.
- b) If liquid has been spilled, or objects have fallen into the product.
- c) If the product has been exposed to rain or water.
- d) If the product does not operate normally by following the operating instructions. Adjust only those controls that are covered by the operating instructions as an improper adjustment of other controls may result in damage and will often require extensive work by a qualified technician to restore the product to its normal operation.
- e) If the product has been dropped or damaged in any way.
- f) When the product exhibits a distinct change in performance - this indicates a need for service.

17. If glass components, including lens and lamp, should break, contact your dealer for repair service.

This product incorporates glass components, including a lens and a lamp. If such parts should break, please handle with care to avoid injury and contact your dealer for repair service. The broken pieces of glass may cause to injury. In the unlikely event of the lamp rupturing, thoroughly clean the area around the projector and discard any edible items placed in that area.

18. Servicing

Do not attempt to service this product yourself as opening or removing covers may expose you to dangerous voltage or other hazards. Refer all servicing to qualified service personnel.



19. Replacement Parts

When replacement parts are required, be sure the service technician has used replacement parts specified by the manufacturer or have the same characteristics as the original part. Unauthorized substitutions may result in fire, electric shock, or other hazards. (Replacement of the lamp only should be made by users.)

20. Safety Check

Upon completion of any service or repairs to this product, ask the service technician to perform safety checks to determine that the product is in proper operating condition.

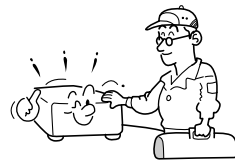

21. Do not leave thermal-paper documents or easily deformed items on top of the unit or near the air exhaust for long periods of time.

The heat from the unit could erase the information on the thermal paper, or cause deformation or warping.

22. When using a wireless LAN PC card (Models equipped with PC card slot):

- Do not use near people with heart pacemakers
- Do not use near electronic medical equipment, or in hospitals or other medical institutions
- Do not use inside aircraft or in places where the wireless LAN card could interfere with electromagnetic signals.

The electromagnetic interference could cause a malfunction, resulting in an accident.

23. If the use of a wireless LAN PC card interferes with another device's electromagnetic signals, cease use immediately. (Models equipped with PC card slot)

The electromagnetic interference could cause a malfunction, resulting in an accident.

24. Do not get your hands between the camera arm and the main unit when setting the camera arm back in its original position. (Models equipped with document camera)

To avoid injury, be careful not to get your hands caught when setting the camera arm back in its original position. Families with children should be particularly careful.

25. Do not carry by the camera arm. (Models equipped with document camera)

Do not carry the projector by the camera arm. Doing so can result in damage or injury.

26. Do not move the projector while the arm is still erect. (Models equipped with document camera)

Always store the arm back in position when moving the projector. Otherwise injury or damage may result.

27. Do not look into the arm light while it is lit. (Models equipped with document camera)

The strong light may cause damage to your eyes or sight.

28. Do not carry the projector by having the terminal cover parts or the PC card cover part

Doing so, the projector may fall if that cover comes off, and injury or damage may result.

IMPORTANT PRECAUTIONS (Continued)

Avoid Volatile Liquid

Do not use volatile liquids, such as an insect spray, near the unit. Do not leave rubber or plastic products touching the unit for a long time. They will leave marks on the finish. If cleaning with a chemically saturated cloth, be sure to follow the product's precautions.

Wireless LAN PC Card (Models equipped with PC card slot)

- Do not connect the supplied wireless LAN PC card to devices other than this unit. Doing so could cause malfunction.
- To protect the PC card from static electricity, touch some nearby metal, such as a doorknob or aluminum window frame, before touching the PC card, to rid your body of static electricity.
- This PC card is a radio product. Concerning the regulations applied in each country/area, please refer to "Information to the user" supplied.

LCD Panel

The life of the LCD panel is limited. Take care over the points below so as to use the panel for years.

- To prolong the life of this panel, never fail to turn the power off when the panel is not in use and make sure that the lamp has gone out. The state of the lamp being extinguished helps enhance the effect of energy saving.
- If the air filter is stained and is clogged up, the main unit inner temperature rises. As a result, the life of the LCD is shortened and a malfunction may also occur. Clean the air filter from time to time and replace it regularly. It is recommended that this replacement be done at the time of replacing a lamp. (Ask a dealer where the unit was purchased or your nearby service station about an air filter for replacement.)

In the spaces provided below, record the Model and Serial No. located at the bottom of your LCD projector.

Model No. _____ Serial No. _____

Retain this information for future reference.

EXEMPTION CLAUSES

- Toshiba Corporation bears no responsibility in the case of damages arising from natural disaster such as earthquakes, lightning, etc., fire not liable to Toshiba Corporation, operating by third parties, other accidents, or use under abnormal conditions including erroneous or improper operation and other problems.
- Toshiba Corporation bears no responsibility for incidental damages (lost profit, work interruption, corruption or loss of the memory contents, etc.) arising from the use of or the inability to use this unit.
- Toshiba Corporation accepts no liability whatsoever for any damages arising from not having followed the descriptions in this Instruction Manual.
- Toshiba Corporation accepts no liability whatsoever for any damages arising from malfunctions arising from combination with equipment or software that is not related to Toshiba Corporation.
- Toshiba bears no responsibility for information being intercepted or leaked due to the use of a wireless LAN, or any damages therefor (models with PC card slot).

OTHER CAUTIONS AND INFORMATIONS

Copyrights

Publicly showing or transmitting commercial imaging software or broadcast or Cable-broad casting programs, either commercially or collecting a fee from the audience, or modifying images using the freeze or resize functions, could violate the direct or indirect copyrights of the imaging software or broadcast program, etc., if done without first consulting with the copyright holder. For this reason, please take appropriate measures before performing one of the actions listed above, including obtaining a license from the copyright holder.

Disposal

This product contains substances which are harmful to humans and the environment.

- The solder used in the PCB manufacturing process contains lead.
- The lamp contains inorganic mercury.

Please dispose of this product or used lamps in accordance with local regulations.

Trademarks

- VGA, SVGA, XGA, SXGA, UXGA are trademarks or registered trademarks of International Business Machines Corporation.
- Macintosh is a registered trademark of Apple Computer, Inc.
- Windows is a registered trademark of Microsoft Corporation in the U.S. and other countries.

Notational Conventions Used in This Manual

References to pages with related information are annotated as follows.

For example, if making a reference to page 36: [p.36](#)

CONTENTS

Before Using

SAFETY PRECAUTIONS	2
IMPORTANT SAFETY INSTRUCTIONS	3
LABEL LOCATIONS	8
POWER SUPPLY CORD SELECTION	9
IMPORTANT PRECAUTIONS	9
EXEMPTION CLAUSES	11
OTHER CAUTIONS AND INFORMATIONS	11
CONTENTS	12

Preparations

Checking the package contents	14
Names of each part on the main unit	15
Names of each part on the control panel and remote control	16
Names of each part on the camera control panel	17
Names of each part on the PC card slot	17
Names of the connection terminals	18
Preparing and using the remote control	19
Placement	21
Connection	22
How to use the PC card slot	23
Installing the application	24

Operations

Turning the power on and off	25
Basic operations	27
Using handy features	29
Using auto setting (Auto setting)	29
Correcting the keystone distortion (Keystone)	30
Cutting off the picture and sound temporarily (Mute)	30
Freezing the image (Freeze)	31
Enlarging the picture size (Resize)	31
Displaying Information	32
Using the wireless LAN PC card	33
Functions	33
Communication mode	33
Preparation	34
Displaying a computer's screen via the projector	35
Displaying a JPEG image saved on a computer via the projector	37
Operating the projector	38
Projecting images stored in a memory PC card	40
Memory PC cards	40
JPEG files	41
Projecting images stored in a memory PC card	41

Using the document camera	44
Preparation of the document camera	44
Image projection with the document camera	44
Using the overlay function	46
Locking the white balance	46
Correcting illuminated defects	47
Sending the camera's images to a computer	48
Storing the camera images into the memory card	50
Operating a computer using the remote control	51
Using the menus	52
How to use the menus	52
The image adjustment menu	53
The default setting menu	53
The display setting menu	54
The PC card setting menu	54
Reset menu	55

Maintenance

Air filter cleaning	56
Lens and main unit cleaning	57
Lamp replacement	57

Others

How to use the supplied software	59
How to use the Projector Configuration Tool	59
How to use the JPEG Conversion Tool	61
Trouble indications	64
Before calling service personal	65
Specifications	67
List of general specifications	67
Document camera specifications	67
List of supported signals (RGB signals)	68
List of supported signals (Y/P _B /P _R signals)	69
List of supported signals (Video, S-Video signals)	69
Pin assignment of COMPUTER-1/2 & MONITOR terminals	69
CONTROL terminal	70
Separately sold products	70

Checking the package contents

Please make sure that the following items are included in the box, along with the main unit. If an item is missing, please contact the store from which you purchased the product immediately.

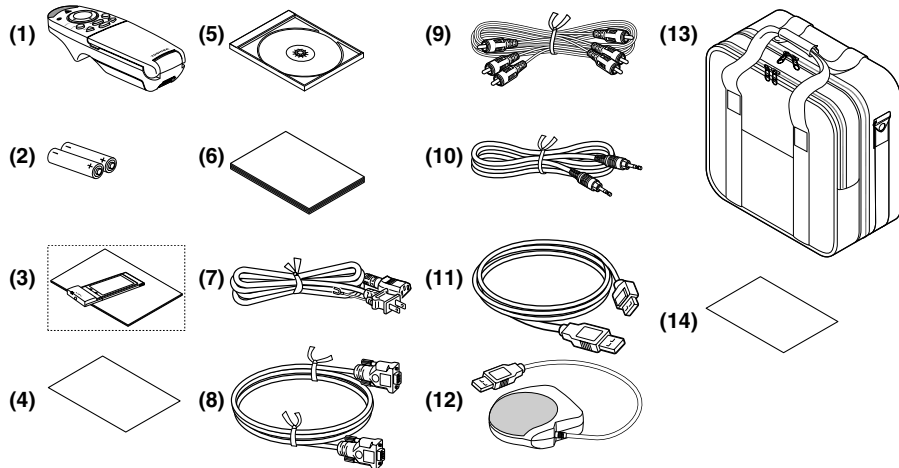

- (1) Remote control
- (2) AAA dry-cell batteries for remote control (2)
- (3) Wireless LAN PC card (See note 1)
- (3) Information to the user (See note 1)
- (4) Quick Reference
- (5) CD-ROM
- (6) Owner's Manual (this document)
- (7) Power cord (See note 3)
- (8) RGB cable
- (9) AV cable
- (10) Audio cable (for computer)
- (11) USB cable (See note 2)
- (12) Mouse remote control receiver (See note 1)
- (13) Carrying bag
- (14) License information (See note 1)

Notes

- 1: Included with models equipped with PC card slot.
 2: Included with models not equipped with PC card slot.
 3: The shape and number of power cords supplied vary depending on the product destination.

◆The Supplied CD-ROM

The supplied CD-ROM contains an owner's manual including information omitted in the Owner's manual (Getting started), Acrobat® Reader™, which is needed to view the manual, and applications [p.24](#) for using the functions of models equipped with a PC card slot.

■ Installing Acrobat® Reader™

Windows: In the CD-ROM, select the **Reader/English** folder, and run **ar500enu.exe**. Follow the on-screen instructions.

Macintosh: In the CD-ROM, select the **Reader/English** folder, and run **Reader Installer**. Follow the on-screen instructions to install the software.

■ Viewing the manual

In the CD-ROM, double-click on **Start.pdf**. Acrobat® Reader™ launches, and the menu screen of the Owner's manual appears. Click on your language. The Owner's Manual cover and list of bookmarks appear. Click on a bookmark title to view that section of the manual. Click on [p.](#) to view a reference page with related information. See the Help menu for more information about Acrobat® Reader™.

Names of each part on the main unit

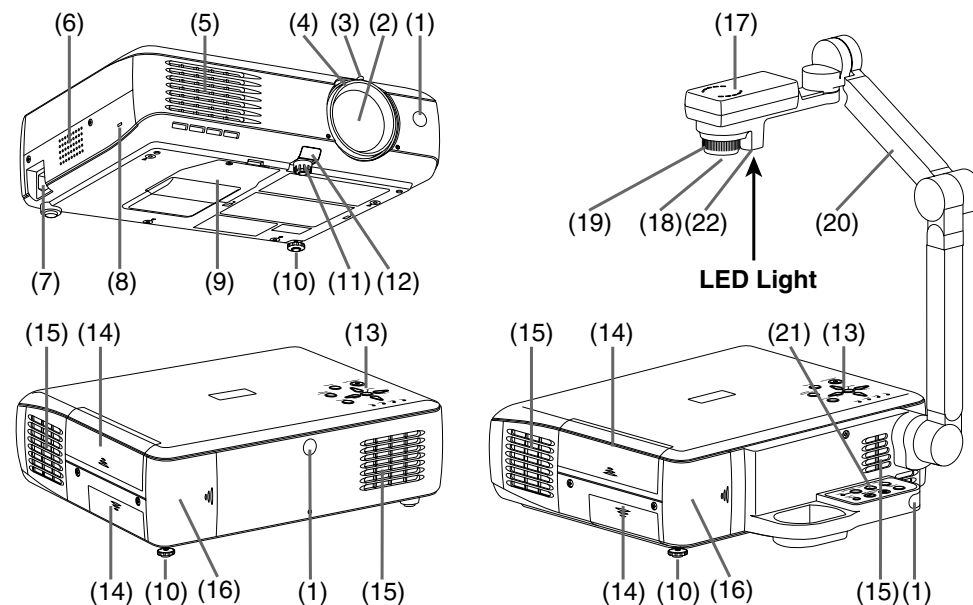

Name	: Function
(1) Infrared remote sensor	: Senses commands from the remote control p.19
(2) Lens	: Projects expanded image
(3) Zooming lever	: Adjusts screen size p.28
(4) Focusing ring	: Adjusts screen focus p.28
(5) Air exhaust	: Expels air that has grown hot inside the projector
(6) Speaker	: Plays audio
(7) AC IN socket	: Connect the supplied power cord here p.25
(8) Anti-theft lock hole	: Attach a security chain, etc. here
(9) Lamp cover	: Remove to replace lamp p.58
(10) Tilt adjuster	: Adjusts the projector's horizontal tilt p.28
(11) Foot adjuster	: Adjusts the vertical projection angle p.28
(12) Foot adjuster release button	: Press to stow the foot adjuster p.28
(13) Control panel	: Operates the projector p.16
(14) Connection terminal cover	: Remove to connect to an external device p.18
(15) Air intake	: Draws in air from outside unit
(16) PC card slot cover <small>[See note 1]</small>	: Remove to mount/remove the PC card p.23
(17) Camera head <small>[See note 2]</small>	: The document camera
(18) Camera lens <small>[See note 2]</small>	: The document camera's lens
(19) Camera focusing ring <small>[See note 2]</small>	: Adjusts document camera focus p.45
(20) Camera arm <small>[See note 2]</small>	: Adjusts the camera angle p.44
(21) Camera control panel <small>[See note 2]</small>	: Operates the document camera p.17
(22) Camera light <small>[See note 2]</small>	: Shines light on the object that the document camera is photographing p.44

Notes

- 1: Models equipped with PC card slot
 2: Models equipped with document camera

Names of each part on the control panel and remote control

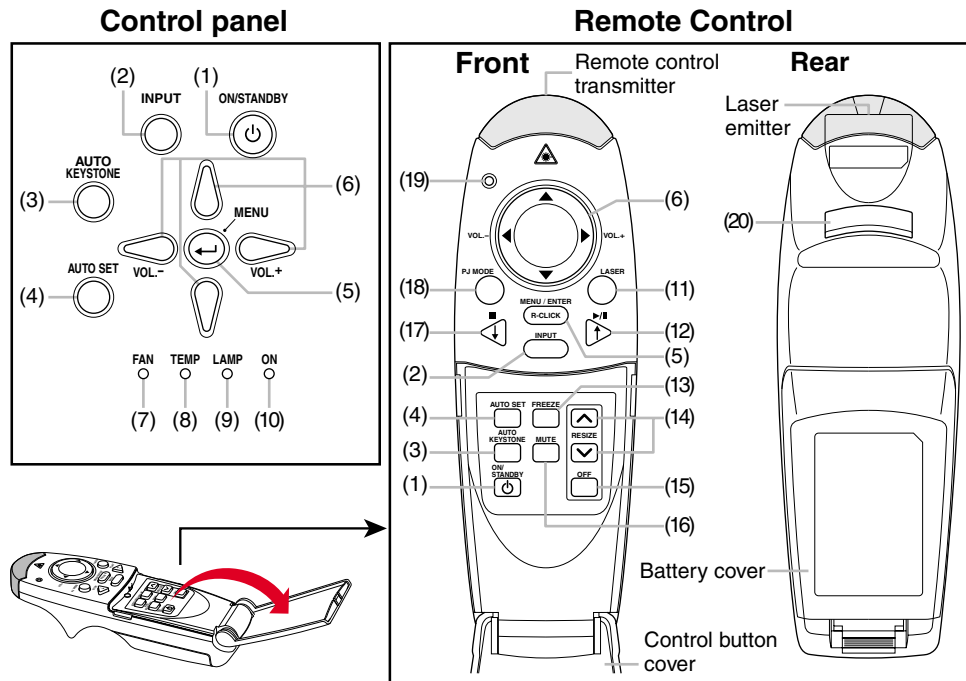

Caution - use of controls or adjustments or performance of procedures other than those specified herein may result in hazardous radiation exposure.

Name	Main Function
(1) ON/STANDBY button	: Turns the power on/off (standby) p.25
(2) INPUT button	: Selects input p.27
(3) AUTO KEYSTONE button	: Adjusts keystone (trapezoidal distortion) p.30
(4) AUTO SET button	: Sets up image and mode p.29
(5) MENU/ENTER button	: Displays menus and makes selections p.52
(6) Selection button	: Menu selections and adjustments, etc. p.52
(7) FAN indicator	: Displays cooling fan mode p.26 p.64
(8) TEMP indicator	: Lights when internal temperature too high p.64
(9) LAMP indicator	: Displays lamp mode p.26
(10) ON indicator	: Displays whether power is on or off p.25
(11) LASER button	: Displays laser point
(12) PLAY button	: Begins PC card slide display p.42
(13) FREEZE button	: Pauses image p.31
(14) RESIZE button	: Enlarges picture size p.31
(15) OFF button	: Turns off enlarged picture display p.31
(16) MUTE button	: Cuts off the picture and sound temporarily p.30
(17) STOP button	: Ends PC card slide display p.42
(18) PJ MODE button	: Switches remote control mode p.20
(19) Transmission indicator	: Lights when remote control transmitting
(20) L-CLICK button	: Left button click of remote control mouse p.51

Names of each part on the camera control panel (Models equipped with document camera)

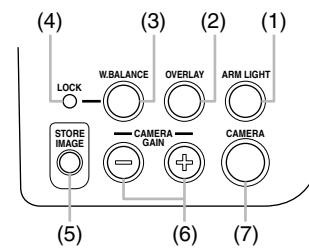

Name	Functions
(1) ARM LIGHT button	: Turns camera light on and off p.44
(2) OVERLAY button	: Turns overlay function on and off p.46
(3) W.BALANCE button	: Switches white balance between auto adjust and lock p.47
(4) LOCK indicator	: Lights when white balance locked p.47
(5) STORE IMAGE button ^(See note 1)	: Stores camera images onto a memory PC card p.50
(6) CAMERA GAIN button	: Adjusts camera gain p.45
(7) CAMERA button	: Switches between camera input and previous input p.45

Notes
1: Models equipped with PC card slot

Names of each part on the PC card slot (Models equipped with PC card slot)

Removing the PC card slot cover

Press on the circle ("O") while sliding the cover in the direction of the arrow. The cover will come off.

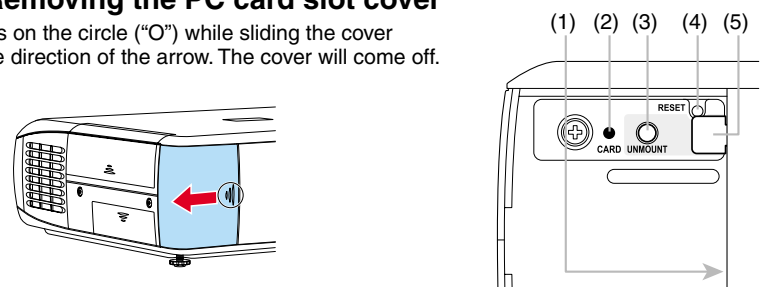

Name	Functions
(1) PC card slot	: Insert PC cards here p.23
(2) CARD indicator	: Displays PC card's status p.23
(3) UNMOUNT button	: Press before removing PC card p.23
(4) RESET switch (inside depression)	: Press if CARD indicator turns red p.23
(5) Eject button	: Press to remove PC card p.23

CAUTION Do not carry the projector by having the PC card slot cover part. Doing so, the projector may fall if that cover comes off, and injury or damage may result.

Names of the connection terminals

■ Removing the connection terminal cover

Press on the circle ("O") while sliding the cover in the direction of the arrow. The cover will come off.

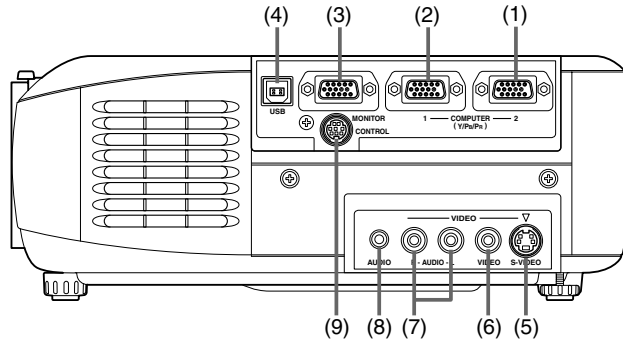
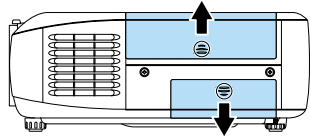

(1) COMPUTER 2 terminal

Input RGB signal from a computer or other source, or a component video signal (Y/P_B/P_R) from video equipment.

(2) COMPUTER 1 terminal

Input RGB signal from a computer or other source, or a component video signal (Y/P_B/P_R) from video equipment.

(3) MONITOR terminal

Connect to a computer display, etc.

(4) USB terminal

Connect to a computer's USB terminal when using the remote-control mouse function. [p.51](#)

(5) S-VIDEO terminal

Input S video signals from video equipment.

(6) VIDEO terminal

Input video signals from video equipment.

(7) AUDIO (L/R) terminal

Input audio signals from video equipment.

(8) AUDIO terminal

Input audio signals from a computer or video equipment with a component video signal output terminal.

(9) CONTROL terminal

When operating the projector via a computer, connect this to the controlling computer's RS-232C port. [p.70](#)

■ Note

- Although this owner's manual abbreviates component video signals as Y/P_B/P_R, the product also supports signals from video equipment marked "Y/C_B/C_R."



CAUTION

Do not carry the projector by having the terminal cover parts. Doing so, the projector may fall if that cover comes off, and injury or damage may result.

Preparing and using the remote control

■ Loading dry-cell batteries into the remote control

① Remove the battery cover.

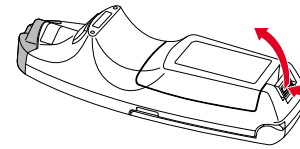

② Insert the dry-cell batteries.

Be sure to align the plus and minus ends of the batteries properly.

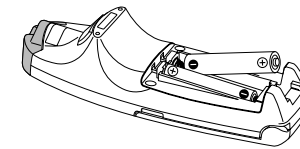

③ Replace the battery cover.

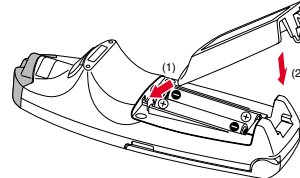

■ Dry-cell batteries

- Remove batteries from remote control when not using for extended periods.
- If the remote control stops working, or if its range decreases, replace all the batteries with new ones.

■ The remote control

- The remote control may fail to operate if the infrared remote sensor is exposed to bright sunlight or fluorescent lighting.
- Do not drop or bang.
- Do not leave in hot or humid locations.
- Do not get wet or place on top of wet objects.
- Do not take apart.
- In rare cases, ambient conditions could impede the operation of the remote control. If this happens, point the remote control at the main unit again, and repeat the operation.

■ Operating the remote control

Point the remote control toward the projector's infrared remote sensor, and press a button on the remote control.

- Operating the projector from the front

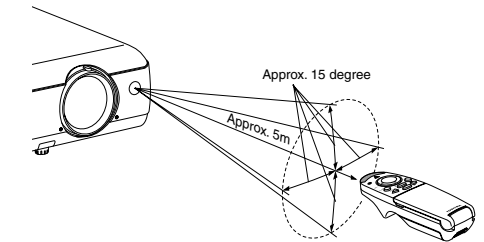

- Operating the projector from the rear

Models without document camera

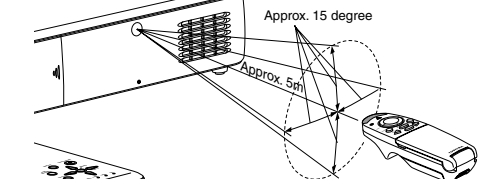

Models equipped with document camera

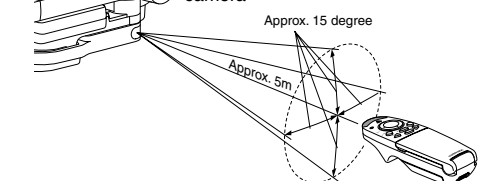

Preparing and using the remote control (Continued)

Switching operation modes

Operation modes should be switched between projector operation and computer operation.

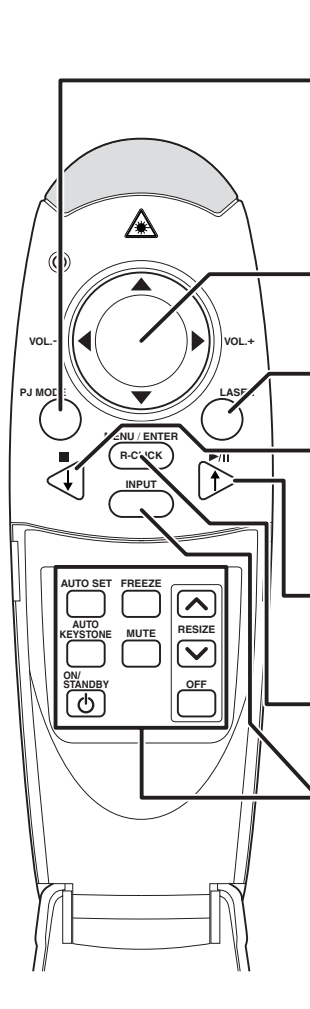

Switching the remote control operation mode.
Pressing this button toggles the mode.
When this button is lit, the remote control is in **[PJ Mode]** (Projector operation mode).
If no operations are made for 30 seconds, this light goes out, and the remote switches back to **[PC Mode]** (Computer operation mode).

[PJ Mode] : Functions as a select button.
If no menu is displayed, adjusts volume.
[PC Mode] : Functions as a mouse pointer control.

Pressing displays a laser pointer, regardless of the mode.

[PJ Mode] : Ends memory card slide display.
[PC Mode] : Functions as a down button. Used to go forward on Microsoft® PowerPoint® slides, etc.





[PJ Mode] : Begins memory card slide display.
[PC Mode] : Functions as an up button. Used to go back on Microsoft® PowerPoint® slides, etc.

[PJ Mode] : Functions as a MENU/ENTER button.
[PC Mode] : Functions as the right mouse button (R-CLIK).

Pressing one of these buttons automatically sets the remote control to **[PJ Mode]**.
If no operations are made for 30 seconds, and the remote switches back to **[PC Mode]**.

The L-CLICK (left click) button on the back of the remote control functions when in **[PC Mode]**.

Notes

- See page 51 for more information on operating a computer.
- For the remainder of this manual, buttons, including those on the control panel (main unit side), are referred to as follows:
Selection button ⇒    ; MENU/ENTER button ⇒ 
With the exception of operating a PC with the remote control p.51, all buttons are used in [PJ Mode].

Placement

Placement Styles

As shown in the figures below, this device can be placed in 4 different styles. The factory setting is “floor-mounted front projection.” Set the **placement style** in the **default setting menu p.53**, in accordance with your needs.

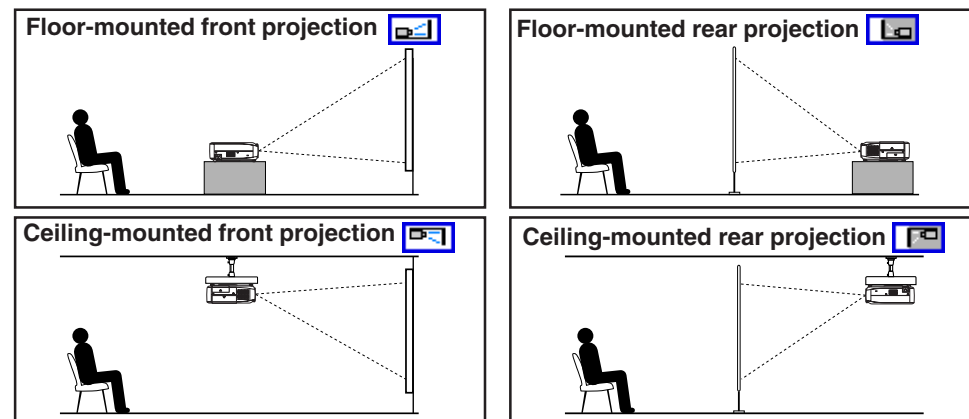

CAUTION

- Always obey the instructions listed in IMPORTANT SAFETY INSTRUCTIONS when placing the unit.
- If you wish to mount the projector on the ceiling, be sure to ask your dealer to do so. Mounting the projector on a ceiling requires special ceiling brackets (sold separately) and specialized knowledge. Improper mounting could cause the projector to fall, resulting in an accident.

Projection Distance and Screen Size

Use the figures, table, and formula below to determine the screen size and projection distance. (Screen sizes are approximate values for full-size picture and no keystone adjustment)

Screen **As seen from above**

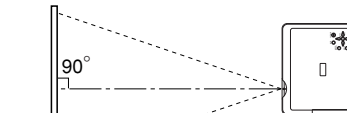

$$a \text{ (min length)} = \frac{\text{projection size (inches)} - 1.7971}{25.395}$$

$$a \text{ (max length)} = \frac{\text{projection size (inches)} - 1.4258}{20.148}$$

As seen from the side

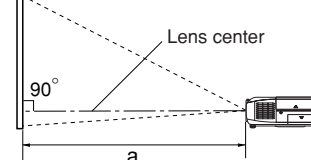

a is the distance (m) between the lens and the screen, and corresponds to a range of 1.50 m to 11.74 m.

screen size (cm)	projection distance a(m)	
	min length (zooming max)	max length (zooming min)
32 (81)	—	1.50
40 (102)	1.50	1.91
60 (152)	2.29	2.91
80 (203)	3.08	3.90
100 (254)	3.87	4.89
150 (381)	5.84	7.37
200 (508)	7.80	9.86
250 (635)	9.77	—
300 (762)	11.74	—

Connection

Before connection

- Read the owner's manual of the device to be connected to the projector.
- Some types of computer cannot be used connected to this projector. Check for an RGB output terminal, supported signal [p.68](#), etc.
- Turn off the power of both devices before connection.
- The figure below is a sample connection. This does not mean that all of these devices can or must be connected simultaneously. (Dotted lines mean items can be exchanged.)

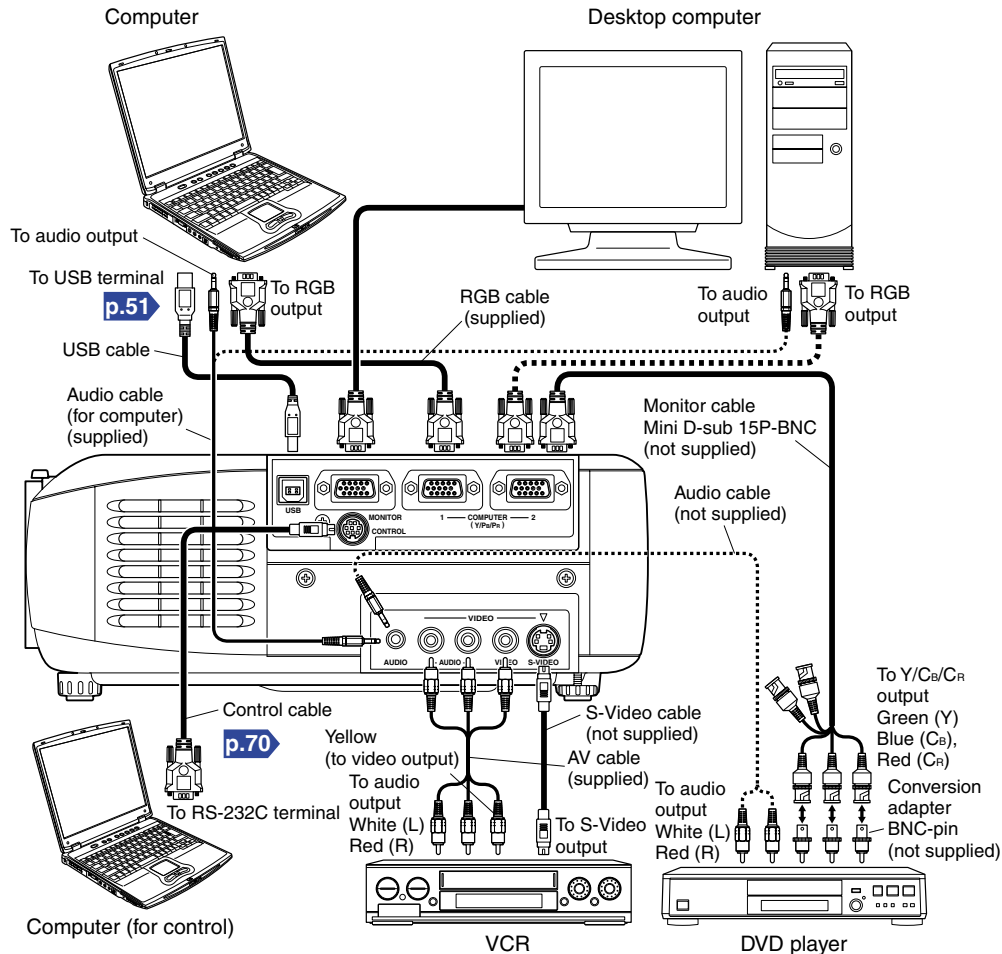

Notes

- COMPUTER terminals 1 and 2 function identically.
- The AUDIO terminal doubles for devices connected to COMPUTER terminals 1 and 2.

How to use the PC card slot

Please read this chapter if the model you purchased includes a PC card slot.

The attached wireless LAN PC card enables you to connect the projector wirelessly with a personal computer that supports IEEE802.11b based wireless LAN. Please note that communication between all the computers based on IEEE802.11b and this projector is not guaranteed. [p.33](#) You can also use a commercially available memory card to project JPEG image files using this projector. [p.40](#) Please follow the steps below when removing or mounting a PC card.

Mounting a PC card

- 1 **Remove the PC card slot cover.**
Press lightly on the circle ("O") while sliding the cover in the direction of the arrow.

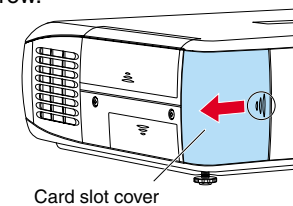

- 2 **Insert the PC card.**
After making sure of the card orientation, press it in firmly until it stops.

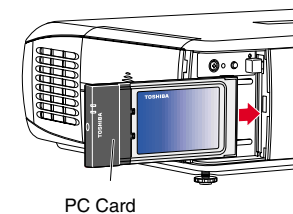

- 3 **Replace the PC card slot cover.**
Replace the PC card slot cover to keep dust from entering.

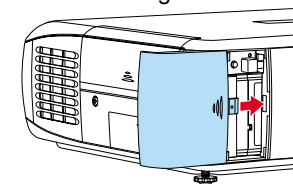

Removing a PC card

- 1 **Look at CARD indicator.**
If it is off, proceed to step 4.

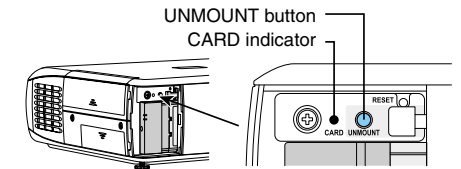

- 2 **Press the UNMOUNT button.**
Begins processing for PC card removal

- 3 **Wait until CARD indicator goes out.**
Never remove the PC card while lit. Doing so could damage the PC card or corrupt your data.

- 4 **Press the Eject button.**

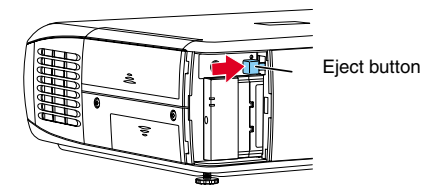

The Eject button is a bit stiff, so press firmly while supporting the projector. Be careful to avoid injury when doing so.

If CARD indicator turns red

Press the RESET switch with a thin pin or similar implement (it is at the bottom of a recess).

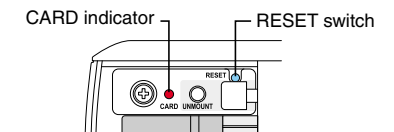

Installing the applications

Please read this chapter if the model you purchased includes a PC card slot.

If you will use the supplied wireless LAN PC card function, install the application on the supplied CD-ROM onto your computer.

System Requirements

Supported OSs: Windows® 98SE, Windows® Me, Windows® 2000, Windows® XP
CPU: Pentium III 750 MHz or higher recommended
RAM: 256 MB or more recommended
Screen area (resolution): 1024 by 768 pixels recommended

Application Types and Major Functions

Wireless utility

This application is used for wireless connections. Use it to send the images from the computer's screen to your projector, and display on the screen.

Projector Configuration Tool

Use to modify wireless LAN and TCP/IP settings.

JPEG Conversion Tool

Use to convert JPEG and other files into a format that can be displayed as a slide show using a memory PC card.

How to install

In the supplied CD-ROM, select the **Applications** folder, and run **setup.exe**. Follow the instructions on your computer screen.

If you are using Windows® XP or Windows® 2000, during installation a dialog box may appear with the following message: has not passed Windows Logo to verify its compatibility with Windows XP (2000). Click "Continue Anyway", and continue with the installation.

When installation is finished, the following shortcuts will appear on your computer's desktop:

Wireless Utility →



Operations [p.35](#)

Projector Configuration Tool →



Operations [p.59](#)

JPEG Conversion Tool →



Operations [p.61](#)

How to uninstall

Select [Start Menu] → [Settings] → [Control Panel] → [Add/Remove Programs], and remove **Toshiba Data Projector** from currently installed programs.

Turning the power on and off

Connecting the power cord

- 1 Insert the power cord connector into the AC IN socket of the projector.
- 2 Insert the power cord plug into a wall or other power outlet.

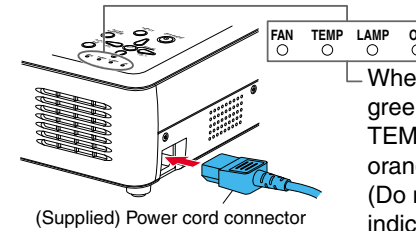

When the power cord is plugged in, the following three green indicators will come on for several seconds: ON, TEMP, and LAMP. Next, the ON indicator will change to orange, indicating standby mode. (Do not perform any operations while the 3 green indicators are lit.)

Removing the lens cover

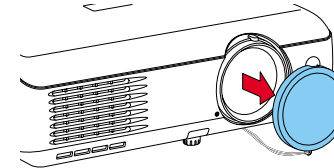

Be sure to remove the lens cover when the power is turned on. If it is left on, it could become deformed due to heat.

Turning the power on

- 1 Press the ON/STANDBY button.

The power turns on, and the following 3 green indicators light: ON, LAMP, and FAN. After a moment, the start-up screen appears.

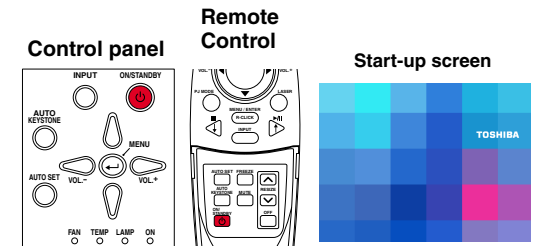

CAUTION

- Do not look into the lens during operation. Doing so could damage your vision.
- Do not block the air intake or exhaust. Doing so could cause a fire due to internal overheating.
- Do not place your hands, face, or other objects near the air exhaust. Doing so could cause burns, deform/break the object.

Notes

- The start-up screen will disappear after a moment. You can dismiss the start-up screen before this by performing any operation. You can also configure the start-up screen not to appear via the **Display setting menu** [p.54](#).
- The first time you use the projector after purchase, after the start-up screen disappears, the Language menu is displayed [p.27](#).

Turning the power on and off (Continued)

Turning the power off

1 Press the ON/STANDBY button.

A message appears on the screen, confirming that you wish to shut off the power. This message will disappear after a moment. (This operation is no longer valid after the message disappears.)

2 Press the ON/STANDBY button again.

The screen turns off, but the internal cooling fan continues to operate for a short while. Then, the projector goes into standby mode.

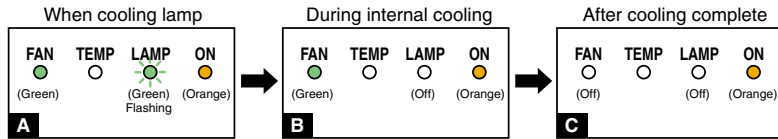

A During cooling, the LAMP indicator flashes. In this state, the power cannot be turned back on. In addition, unplugging the power cord in this state will shorten the life of the lamp.

B After the LAMP indicator goes off, the cooling fan continues to operate for a short while, in order to expel excess internal heat. If you are in a hurry, there is no problem with unplugging the power cord in this state.

C In standby

Note

- The projector consumes about 6W of power in standby (models equipped with PC card slot consume about 18W). We recommend that you unplug the power cord if you will not be using the projector for an extended period.

PRECAUTIONS

- Before unplugging the power cord, make sure that the LAMP indicator is off. Unplugging the power cord and cutting off the power while the projector is running or being cooled will shorten the life of the lamp. **However, please unplug the power cord if the projector locks up or acts abnormally.**
- If the power cord was unplugged before cooling was complete, give the lamp sufficient time to cool before plugging it back in. If the lamp overheats it may fail to light, and its lifetime will be shortened.

LCD Panels

LCD panels wear out. In order to prolong the lifetime of your LCD panel, take the following precautions.

- In order to extend the lifetime of the LCD panel, always turn off the power when not in use, and make sure that the lamp is off. Keeping the lamp off is also very effective at saving electricity.
- If the air filter becomes dirty and clogged, the projector's internal temperature will rise, shortening the lifetime of the LCD panel and causing malfunctions. Clean the air filter from time to time [p.56](#), and replace it periodically. Contact the store where you purchased your projector, or your local Service Station for replacement air filters.

Basic operations

Preparations

- Place the projector, and correctly connect all devices.
- To operate via the remote control, [PJ MODE] [p.20](#) must be selected.

Press the PJ MODE button. The button lights up. This light will go out 30 seconds after operations are complete. If necessary, press the button again.

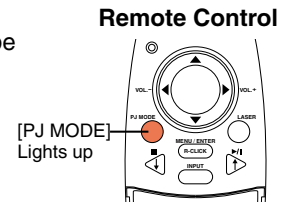

1 Turn on the power.

Turn on the power, following the instructions in "Turning on the power" [p.25](#).

2 Select language (When using for first time).

When the projector is used for the first time after purchase, a message is displayed on the screen, and the language menu appears. The default language is English. (If the screen focus is not on the menu, adjust according to step [6](#).)

- Use the **▲ ▼** buttons to select the desired language, and press the **⏻** button.

A message displays the selected language.

- Press the **⏻** button to apply.

English	English
Français	French
Deutsch	German
Italiano	Italian
Español	Spanish
Português	Portuguese
日本語	Japanese
中文(简体字)	Chinese (simplified)
中文(繁體字)	Chinese (traditional)
한국어	Korean

Notes

- After the first time the projector is turned on, the Language menu does not appear upon startup. However, from the **Reset** menu [p.55](#) select "**Reset all**" to display the Language menu the next time the projector is turned on.
- The language can also be set via the **Display setting menu** [p.54](#).
- This owner's manual assumes that English has been selected.

3 Place connected device(s) in operating status.

Turn on and boot up connected computers and other devices.

4 Select input.

- Press the **INPUT** button.

A list of inputs appears on the screen.

- Use the **▲ ▼** buttons to select the desired input, and press the **⏻** button.

The picture for the selected input is projected.

Computer (1)
Y/Pb/Pr(1)
Computer (2)
Y/Pb/Pr(2)
Video
S-video
PC Card
Camera

Basic operations (Continued)

5 Projector placement angle adjustments

The placement angle and the height of the projected image can be adjusted by the foot adjuster.

- 1 Lift up the front of the projector until it is at the desired angle, then press the foot adjuster release button.

The foot adjuster extends. Release the button to lock the position.

- 2 Turn the foot adjuster to fine-tune the angle.

- 3 To adjust the horizontal angle, use the tilt adjuster.

To stow the foot adjuster, hold up the projector while pressing the foot adjuster release button, then slowly lower the projector will the button depressed.

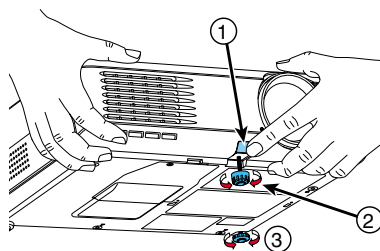

6 Adjusting the picture size and focus

- 1 Use the zooming lever to adjust the screen size.

- 2 Use the focusing ring to adjust the focus.

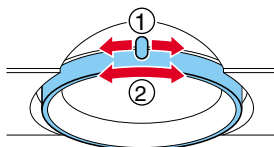

7 Adjusting the volume with the ◀ ▶ buttons

The speaker volume can be adjusted when an audio signal is being input.

Notes

- Note that the lamp characteristics may rarely cause the brightness to fluctuate slightly.
- A lamp is consumable supplies. If used for extended periods, images will appear dark, and the lamp could burn out. This is characteristic of a lamp, and is not malfunction. (The lifetime of the lamp depends on conditions of use.)
- The LCD panel is made using extremely advanced technology, but there may be black spots (pixels that do not light) or bright spots (pixels that are constantly lit) on the panel. Please note that these are not malfunctions.
- Although this projector supports a wide range of RGB signals [p.68](#), any resolutions not supported by the model (XGA or SVGA, depending on the model) will be expanded or shrunk, which will affect image quality slightly. To view high-quality images, it is recommended that the computer's external output should be set to the projector's resolution.
- With some models of computer having LCD displays or the like, displaying images simultaneously on the projector and the monitor's display may prevent the images from displaying properly. If this happens, turn off the computer's LCD display. For information on how to turn off the LCD display, see the owner's manual of your computer.
- If a signal not supported by the projector is input, the icon will appear.
- If a no signal is being input from the connected device, the icon will appear.
- If an unavailable operation button is pressed, the icon will appear.

Using handy features

- To operate via the remote control's buttons, [PJ MODE] must be selected. Press the PJ Mode button. The button lights up. This light will go out 30 seconds after operations are complete. If necessary, press the button again.

Using auto setting (Auto setting)

This function sets up the projector to the optimum state for each type of the input signal by using simple operations.

- 1 Press the AUTO SET button.

The Auto setting menu appears.

- 2 Press the AUTO SET button again.

The menu item is automatically adjusted/set.

For computer input, the icon will appear during processing.

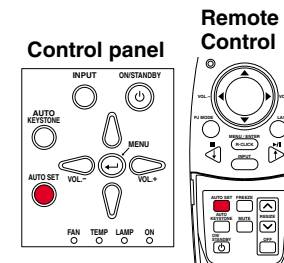

Note

- Auto adjustment/setting may not be performed correctly for input signals other than those supported by the projector [p.68](#), [p.69](#).

Manual adjustment and setting

The menu items vary according to the input type, as shown in the table below.

Use the buttons to adjust the items in the table below, then press the button when you are finished. The menu disappears.

Input	Item	Description
Computer (1) Computer (2)	Phase	Adjust with to eliminate flicker.
	Frequency	Adjust with to eliminate periodic patterns and flickering when many vertical lines appear in the screen.
	H-position	Move left Move right
	V-position	Move up Move down
Y/Pb/Pr(1) Y/Pb/Pr(2)	Phase	Adjust with to eliminate flicker.
	Signal format	[: Enter to setting mode] → [: Select one of the following] → [Apply:] 480i(525i)@60Hz/480p(525p)@60Hz/ 576i(625i)@50Hz/576p(625p)@50Hz/ 720p(750p)@60Hz/720p(750p)@50Hz/ 1080i(1125i)@60Hz/1080i(1125i)@50Hz/ 1035i(1125i)@60Hz/1152i(1250i)@50Hz
Video S-video	Video mode	[: Enter to setting mode] → [: Select one of the following] → [Apply:] NTSC/PAL/SECAM/PAL-N/PAL-M/PAL60/NTSC4.43
Camera	Shutter speed	Set to local line frequency: 50Hz 60Hz

Using handy features (Continued)

■ Correcting the keystone distortion (Keystone)

When the foot adjuster [p.28](#) is used to change the projection angle, the picture will undergo keystone (trapezoidal) distortion. This projector is capable of correcting this keystone distortion.

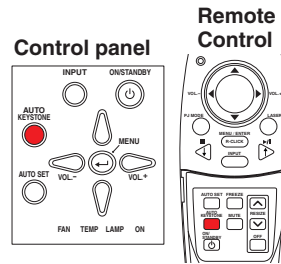
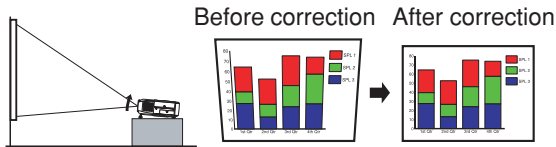



① Press the AUTO KEYSTONE button.



The Keystone menu appears.

② Press the AUTO KEYSTONE button again.

The keystone distortion is automatically corrected. The  icon will appear during processing.

● Manual adjustment

Use the   buttons for keystone adjustment. When the adjustment is finished, press the  button. The menu disappears.

Item	Description
 Keystone	Shrink screen bottom   Shrink screen top

■ Notes

- Depending on the amount of keystone adjustment and the contents of images, some information may be lost, or the picture quality may suffer.
- Keystone adjustment will not change the shape of the menus.

■ Cutting off the picture and sound temporarily (Mute)

When you want to temporarily project the images of another projector, overhead projector, etc., this projector's images and sound can be turned off.

● Press the remote control's MUTE button.

The picture and sound are cut off. The Mute function is released when pressing the MUTE button again.

The  icon will appear while mute is in effect.

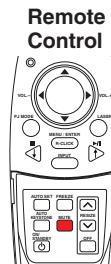

■ Freezing the image (Freeze)

The image being projected can be made to be frozen. This function is to be used to pause a video during a presentation, etc.

● Press the remote control's FREEZE button.

The picture is paused. The Freeze function is released when pressing the FREEZE button again.

■ Notes

- The  icon will appear while freeze is in effect.
- The freeze function can be used on the resize function. Other operations will release the freeze.
- Even if an image is frozen on the projector, it is still changing on the video or other equipment.



■ Enlarging the picture size (Resize)

The image being projected can be enlarged.

① Press the remote control's RESIZE button.

The enlargement ratio is increased each time the RESIZE  button is pressed. While the button is pushed, the image continues increasing to a limit.



② To decrease the enlargement ratio, press the remote control's RESIZE button.

The enlargement ratio is decreased each time the RESIZE  button is pressed. (The image cannot be shrunk to less than its original size.)



③ Press and hold down the buttons to move the enlarged area.



④ Press the OFF button to undo the resize.

The resize is released, and the image returns to its original size.

■ Notes

- The  icon will appear while resize is in effect.
- An enlarged image can be frozen using the FREEZE button. The resize function on a frozen image can also be used.
- Operations other than freeze will release the resize.
- Since the enlargement is performed using digital processing, enlarging the image will cause it to appear jagged.
- Rarely, the picture could become garbled while the enlarged area is being moved.

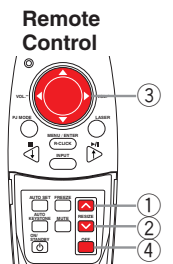

Using handy features (Continued)

■ Displaying Information [Status display]

This displays information about the input signal, lamp use time, etc.

● Press the button twice.

When the  button is pressed once, the **Setting display menu** appears. Pressing it again displays information [p.52](#). The table below shows what kind of information is displayed. Press the button again to dismiss the display.

“Yes”: displayed, “No”: not displayed

Item	Description	Computer	Y/P _B /P _R	Video S-video	PC Card	Camera
Input	Input source name	Yes	Yes	Yes	Yes	Yes
RGB signal mode	RGB input mode ^[Note 1]	Yes	No	No	No	No
H-resolution	Horizontal resolution (in bits)	Yes	No	No	No	No
V-resolution	Vertical resolution (in bits)	Yes	No	No	No	No
H-frequency	Horizontal sync frequency	Yes	No	No	No	No
V-frequency	Vertical sync frequency ^[Note 2]	Yes	No	No	No	No
Sync	Sync signal polarity ^[Note 3]	Yes	No	No	No	No
Signal format	Y/P _B /P _R signal format	No	Yes	No	No	No
Video mode	Color method of video signal	No	No	Yes	No	No
Card type	PC card type	No	No	No	Yes	No
Shutter speed	Shutter speed of document imaging camera	No	No	No	No	Yes
Lamp time	Time of lamp use ^[Note 4]	Yes	Yes	Yes	Yes	Yes
Version	Firmware version ^[Note 5]	Yes	Yes	Yes	Yes	Yes
MAC address	See page 59 p.59	No	No	No	Yes ^[Note 6]	No
SSID	See page 60 p.60	No	No	No	Yes ^[Note 6]	No
DHCP	See page 60 p.60	No	No	No	Yes ^[Note 6]	No
IP address	See page 60 p.60	No	No	No	Yes ^[Note 6]	No
Subnet mask	See page 60 p.60	No	No	No	Yes ^[Note 6]	No
Gateway	See page 60 p.60	No	No	No	Yes ^[Note 6]	No

Notes

- 1: The mode of supported RGB signals [p.68](#) is shown.
- 2: Same as the refresh rate of the computer signal.
- 3: Sync signal polarity shown as P (positive) or N (negative) for [H/V].
- 4: Displays **[Lamp time]** as a measure of when the lamp should be replaced. (Cannot be used as a counter of guaranteed lamp time.) When the time displayed approaches 2,000 hours, consult with a store about getting a TLPLW1 replacement lamp (sold separately) prepared.
- 5: **[Version]** shows the version of the projector's internal control program. This version is referred to for customer service, etc.
- 6: Displayed when wireless LAN PC card is being used.

■ Notes

- The displayed information will not be refreshed if the status changes. To refresh the information, dismiss the display, then display it again.
- Conducting another operation while information is being displayed dismisses the display.

Using the wireless LAN PC card

Please read this chapter if the model you purchased includes a PC card slot.

■ Functions

The following functions are available via wireless communications, when the wireless LAN PC card and dedicated **Wireless Utility software** [p.24](#) included with this projector are used.

Note: Toshiba does not guarantee operation if a wireless LAN PC card other than the one supplied with this product is used.

1) Displaying a computer's screen via the projector

The computer's desktop screen can be sent, as well as the screens of a variety of software applications, to the projector for display.

2) Displaying an image saved on a computer via the projector

JPEG files can be sent to the projector for display.

3) Sending images taken with the projector's document camera to a computer

This function is for models equipped with document camera.

See "Sending the camera's images to a computer" [p.48](#) for details.

4) Operating the projector by means of a computer

Some of the same functions available from the remote control can be performed.

■ Communication mode

This projector supports both Ad-hoc and Infrastructure Communication modes.

Ad-Hoc Communication Mode

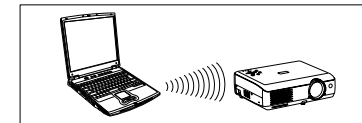

This is transmission mode to communicate between wireless LAN equipment. Wireless communication can be performed via the simple configurations.

This function can only be used if the projector is in range of the computer's wireless signals.

For security reason, confirm the specifications of your computer for the distance that the radio wave can reach. The coverage of this projector may vary, depending on the computer and the surrounding environment. When tested with a PC manufactured by Toshiba with built-in wireless LAN system, the coverage is approximately 60 m. This figure is not guaranteed and should be considered as merely a guideline.

Infrastructure Communication Mode

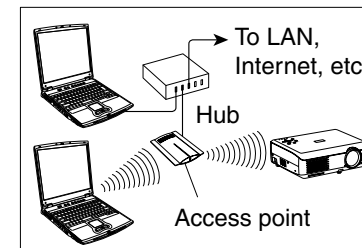

A mixed wireless and wired LAN can be created via access points. Connecting to the rest of the world via a wired LAN or the Internet generally requires a high level of security.

Use the appropriate transmission mode for your network environment. The instructions in this owner's manual assume that you will be using a simple ad-hoc communication mode setup.

Using the wireless LAN PC card (Continued)

■ Preparation

● Mount the supplied wireless LAN PC card into the projector, and select PC card input

Referring to “Mounting a PC card,” p.23 mount the supplied wireless LAN PC card, then select PC card input in accordance with “Select input” p.27.

● Projector settings

The factory settings can be used as-is. If necessary, conduct the following settings, referring to “How to use the menu” p.52 and “The PC card setting menu” p.54.

• [Communication mode]:

Your projector is set to Ad-Hoc in the factory. See “How to Use the Projector Configuration Tool” p.59 if you would like to set the mode to **Infrastructure**. This menu item is used only for channel confirmation and the mode change from **Infrastructure** to **Ad-Hoc**.

• [Channel]

This item cannot be changed currently. This is function for the future.

• [Encryption]

Set the security encryption level. The higher the number of bits, the stronger the encryption, and hence the harder it will be for a third party to decipher your communications. However, setting higher encryption levels will slow down communication speed.

• [Key]

The key must be set for any **encryption** setting other than **None**. [64-bit] sets the **key** length to 5 characters, [128-bit] to 13.

• [Projector name]

This can be used to identify projectors when communicating with multiple projectors, or if there is a possibility that another person who is out of communication range will be using the same projector. It is recommended this is set to prevent wrong transmission.

● Installing the applications

Install the applications on your computer, in accordance with “Installing the applications” p.24.

● Computer settings

Refer to instruction manuals of your computer or wireless LAN PC card to perform the following settings.

- Select **Ad-Hoc** (for some PC cards, this is **Peer-to-Peer Group**).
- Set the **Channel** to channel assigned to the projector (in factory reset mode, this is set to 10). (For some computers, you cannot set the channel in Ad-Hoc mode. For this case, use infrastructure communication mode.)
- Set **SSID** (For some types of PC card, use **Network Name** instead) as the same as projector’s **SSID** (at factory shipment, this is set to **DPJ**).
- If **Encryption** and **Key** are set on the projector, set to the same values.

■ Displaying a computer’s screen via the projector

① Launch the Wireless Utility software application.

When the **Wireless Utility** launches, the **Screen image** transmission mode window appears on the computer screen.

To switch to the **Screen image** transmission mode window from another mode (**File** or **Document camera**), click on the **Screen Image** icon .

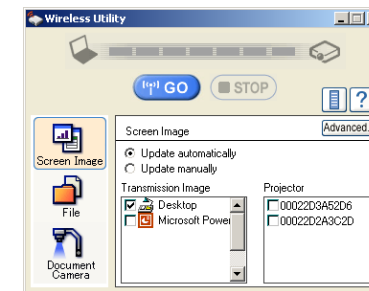

② Select Transmission mode.

Click on **Update automatically** or **Update manually**. See step ⑥ for the meanings of **Update automatically** and **Update manually**.

③ Click on the Advanced button.

The **Advanced Settings** dialog appears. Set the dialog as shown below, as necessary.

• Interruption

Select the **No Interruptions** checkbox to prevent other computer from sending interrupts to the projector during your transmission.

• Mode

Selecting **High quality** improves the quality of the projected image, but lowers communication speed. Selecting **High speed** has the opposite effect.

• Window

Select the **Place in Tasktray at the start of transmission** checkbox to iconify the **Wireless Utility** and place it in the computer’s tasktray when transmission initiated.

To display the window, double click on this icon, or right click and select **Open** from the popup menu. Transmission can be started and stopped from this popup menu in accordance with the preceding instructions, without displaying the **Wireless utility** window.

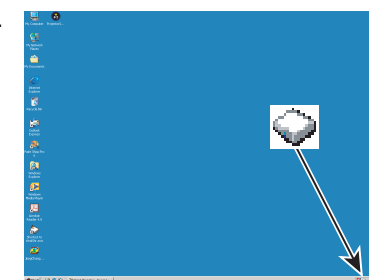
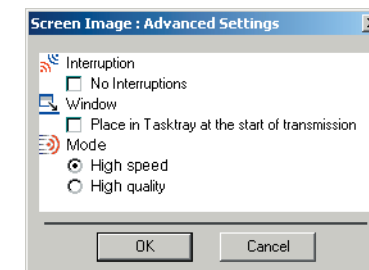

Using the wireless LAN PC card (Continued)

- 4 Select the screen image you wish the projector to display.

Select Desktop

The computer screen image is transmitted as-is.

Select application window

Select a running application (e.g. Microsoft® PowerPoint®), and send that application's window only.

The desktop and a list of running applications are displayed. Select the desired application from this list. (If the desired application is not on the list, launch it. Note that if too many applications are running, it will consume the computer's resources, which could slow communication speed.)



- 5 Select the projector to be transmitted.

A list of the MAC addresses of the wireless LAN PC cards (p.32, p.59) mounted on the projectors that are available for transmission appears. (When a projector name is set, that name appears instead of MAC address.) Select the checkbox of the projector you wish to transmit to from this list. Then icon  is displayed on the projector's screen for few seconds.

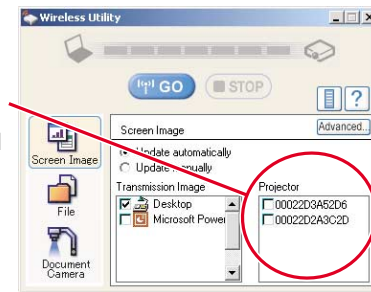

It is possible to select up-to four projectors.

- 6 Click on the  button.

When "Update automatically" is selected in step 2

Screen images are sent consecutively after the  button is clicked.

When "Update manually" is selected in step 2

A single screen image is sent when the  button is clicked.

- 7 To halt transmission from Update automatically, click on the  button.

If the **Wireless Utility** icon has been placed in the tasktray, double click on the icon to display the window, then halt transmission, or right click on the icon, and halt transmission.

Notes

- It may not be possible to transmit the images from movie player or other video applications.
- If using consecutive transmission, the transmitted image refresh rate depends on the performance of the computer you are using.
- The projector screen may have a few differences from the computer screen.
- It is not possible to transmit to a projector that is already receiving from another computer.
- If you selected application window in step 4, if that application is not active (in use), the image may not be correctly displayed by the projector.

■ Displaying a JPEG image saved on a computer via the projector

- 1 Launch the **Wireless Utility** software application.

The **Screen image** transmission mode window appears on the computer's screen.

- 2 Click on the **File** icon .

The **Wireless Utility** window changes to **File** transmission mode.

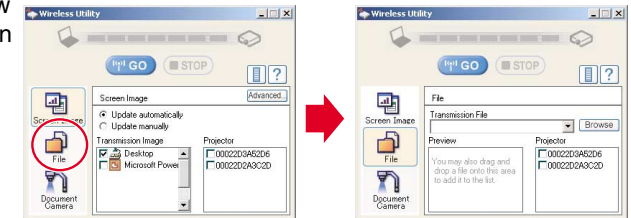

- 3 Click on the **Browse** button, and select the file to send.

Clicking on the **Browse** button displays the **Open** dialog box. Select the file to send, then click on the **Open** button.

The selected file is added to the pull-down list in the **Wireless Utility's** **Transmission File** field.

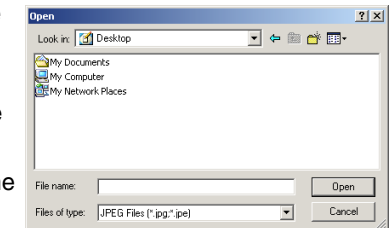

- 4 Select the file to be sent from the pull-down list of the **Transmission File** field.

Click on the **Transmission File** field's  button to display the pull-down list. Select the file to be sent from this list.

A thumbnail of the selected file appears in the **Preview** box. The file displayed here will be transmitted.

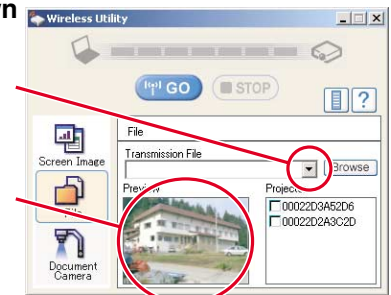

Step 3 can be skipped.

The way that drag and drop the file to be sent from the desktop or Windows Explorer into the **Preview** box is also available. In this case as well, the selected file is added to the file pull-down list **Transmission File** field's.

Using the wireless LAN PC card (Continued)

5 Select the projector to be transmitted.

A list of the MAC addresses of the wireless LAN PC cards (p.32, p.59) mounted on the projectors that are available for transmission appears. If projector name has been set up already, it is shown instead of the MAC address. Select the checkbox of the projector to be transmitted to from this list. Then icon  is displayed on the projector's screen for few seconds. It is possible to select up-to four projectors.

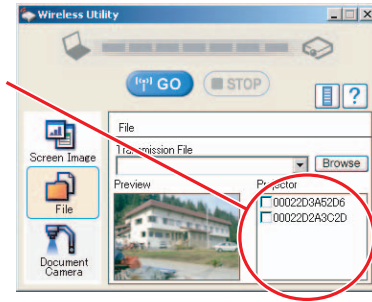

6 Click on the button.

The selected file's image is displayed by the projector.

Note

- Only one file can be sent at a time. To send another file, repeat steps 4 and 6.

Operating the projector

This function can be used with any projector input.

Note, however, that this will not function with a memory PC card.

1 Launch the Wireless Utility software application.

The **Screen Image transmission mode** window appears on the computer's screen.

2 Click on the Remote Control button .

The **Remote Control** window appears.

As the **Wireless Utility** window is still displayed, you can operate the projector via the **Remote Control** window, while using the **Wireless Utility's** functions.

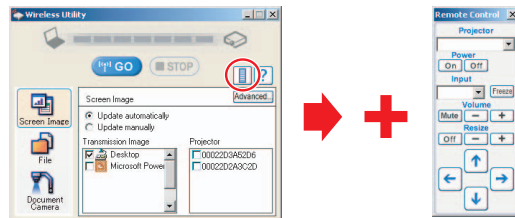

While it is possible to use this function merely to operate the projector, closing the **Wireless Utility** also closes the **Remote Control** window.

3 Select the projector to be operated.

In the **Remote Control** window, click on the  button, and select the desired projector from the pull-down list. Only one projector can be selected. (It is not possible to operate multiple projectors.)

Then icon  is displayed on the projector's screen for few seconds.



4 Click on the Remote Control window's buttons.

The function of each button and box is as follows:

Power On: Turns projector power on.

Power Off: Turns projector power off.

Note, however, that if **Standby mode** is set to **Economy** from the **Default setting** menu (p.53), it is not possible to switch from **off** to **on**. (Standby power consumption during **Economy** is about 6W.)

Input (box): Click on the  button, and select the desired input from the pull-down list.

Mute: Cuts off picture and sound. Click again to restore picture and sound.

Freeze: The picture is paused. Click again to release the freeze function.

Volume (+/-): Adjusting sound volume.

Resize (+/-): Displays expanded image.

↑/↓/←/→: Moves expanded image.

Resize Off: Restores picture to its original size.

5 To quit, click on the button on the Remote Control window.

Performing this does not close the **Wireless Utility** window.

To exit both the **Wireless Utility** and the **Remote Control**, click on the  button on the **Wireless Utility** window.

Projecting images stored in a memory PC card

Please read this chapter if the model you purchased includes a PC card slot.

Models equipped with PC card slot are able to read JPEG files stored on a memory PC card, and display them on the screen.

This allows you to give presentations without a computer, create advertising screen board using the auto slide show function, and more. (It is not possible to reproduce animation effects, such as those produced by Microsoft® PowerPoint®.)

Memory PC cards

PC card slot types

The PC card slot installed on this projector is PC Card Standard TYPE II-compliant. Please use memory PC cards and conversion adapters compliant with this type of PC card slot.

Supported storage media types

This projector supports the following types of ATA-compliant storage media. This owner's manual refers to the combination of the ATA conversion adapter and media in use as a "memory PC card."

Storage media that can be used as-is

Flash ATA card, TOSHIBA Mobile Disk

Storage media that can be used in combination with each of the ATA conversion adapter types

SmartMedia™, compact Flash cards, SD memory cards

Note that inserting conversion adapters and memory cards with different functions than above, and other memory cards (excluding the supplied wireless LAN PC card) into the projector could damage the PC card or cause malfunctions.

Memory PC Cards Whose Operation Have Been Confirmed

Please note that presence on this list is not a guarantee of operation.

- TOSHIBA Mobile Disk: PAMHD005(5GB), MEHDD20A(2GB)
- Flash ATA cards: I-O DATA PCFCA-96M (96MB), PCFCA-128M (128MB)
- SmartMedia™: TOSHIBA PDR-SM16 (16MB), PDR-SM32 (32MB), PDR-SM64 (64MB)
- Adapters: FUJIFILM PC-AD3B, OLYMPUS MA-2
- Compact Flash cards: SanDisk SDCFB-64-505 (64MB), SDCFB-128-505 (128MB)
- Adapters: SanDisk SDCF-31
- SD memory cards: Panasonic RP-SD032 (32MB)
- Adapters: Panasonic BN-SDAAP3

The TOSHIBA IPC5019A SmartMedia™ PC card adapter is not ATA-compliant, and so cannot be used by this projector.

Backing up data

Toshiba recommend that you back up the data on the memory PC card before use. (Toshiba assume no liability for losses incurred by data lost through the use of this projector.)

JPEG files

- 1) Folder names may be up to 19 characters long, and file names up to 14 characters including file extensions.
- 2) Supported file extensions are jpg, JPG, jpeg, and JPEG.
- 3) The maximum number including both folders and files is 512.
- 4) Some JPEG files are not supported by this projector.
- 5) Resolutions above 1,024 x 768 pixels will be displayed in compressed form.

The limitations in 4), above can be alleviated by converting the JPEG file with the supplied **JPEG Conversion Tool** [p.61](#) software application.

Projecting images stored in a memory PC card

- Switch to **[PJ Mode]** [p.20](#) to operate the remote control's buttons.

1 Mounting a memory PC card

Mount a memory PC card into the PC card slot, in accordance with "Mounting a PC card" [p.23](#).

2 Selecting PC card input

When PC card input is selected, data readout from the memory PC card begins, and a list of thumbnails is displayed on the screen. The figure below is an example of this process. The actual display will vary depending on the data stored on your memory PC card.

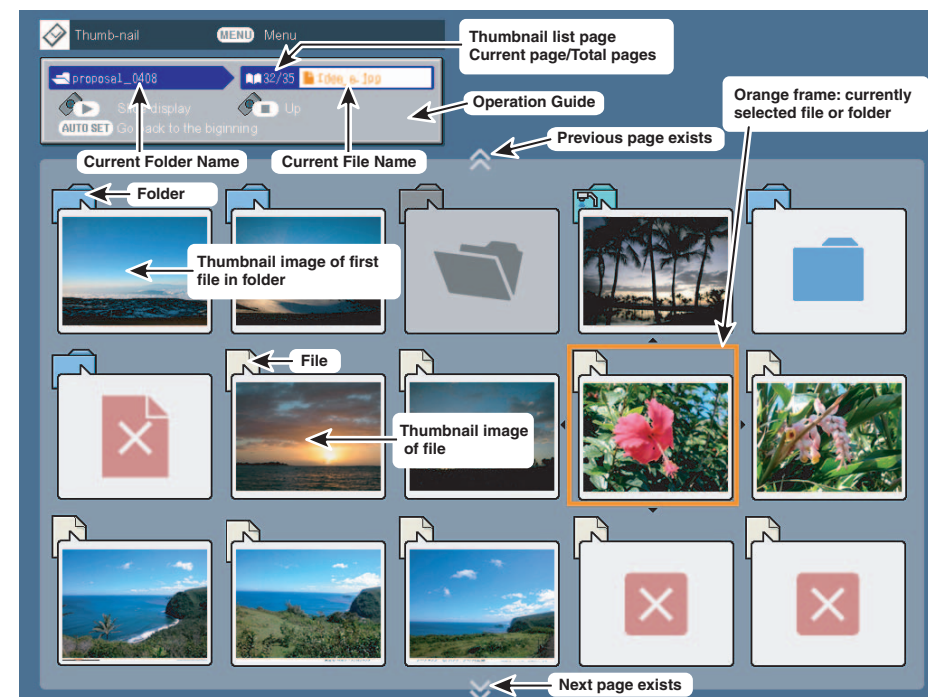

Projecting images stored in a memory PC card (Continued)



Indicates that only folders are inside the folder.



Indicates that an unsupported JPEG or other file is present.



Indicates that the JPEG or other file is not supported.



Indicates a folder for files taken/stored by the document camera. [p.50](#)



Indicates that there is no data to be displayed in the folder.

3 Searching for a target file

- Use the buttons to move the orange frame over the desired file or folder.
- If there are multiple pages of thumbnails, click the button on the bottom row to go to the next page, and the button on the top row to go to the previous page.
- To open a folder, move the orange frame over the desired folder, and click on the remote control's button. It is possible to navigate down up to 5 levels using the same procedure.
To return to the next level up, click on the remote control's button.

4 Displaying slides

- When a file is selected, pressing the remote control's button displays a slide, and the image of the selected file is shown in full-screen view.
- To return to thumbnail display screen, click on the remote control's button.

5 Changing slides

Press the remote control's buttons when a slide is displayed to change slides. (: previous slide; : next slide. The buttons are not available.)

Notes

- The thumbnail display order and slide order goes in order from shortest file name to longest. If two file names have the same number of characters, they are ordered numerically if numbers are used in the file name, and alphabetically otherwise.
- It is possible to give presentations without using a computer by converting presentations created with Microsoft® PowerPoint® into JPEG files using the **JPEG Conversion Tool**, and storing them on a memory PC card. [p.62](#)
Note, however, that functions such as animation effects and hyperlinks cannot be used, so it should be tested before the actual presentation.

The following functions can be used via remote control operation and menu settings.

● Slide show function

- Press the remote control's button when a slide is displayed to begin a slide show, and cycle through the slides automatically.
The slides' **display interval** (time) can be set via the **Interval** setting on the **PC card setting menu** [p.54](#).
- To stop the slide show, press the remote control's button.

● Auto. Demo function

- From the **PC card setting menu** [p.54](#), **On** is selected for **Auto. Demo**, then a slide show begins automatically when a memory PC card is inserted and input switched to PC card input. At this time, the JPEG files in the root directory of the memory PC card are used in the slide show.
- From the **PC card setting menu**, **Auto.** is selected for **Input select mode** and **On** is selected for **Auto. Demo**, and a memory PC card is mounted, then a slide show begins automatically when the projector's power is turned on.
- To stop the slide show, press the remote control's button.

● File deletion function

Select the file to be deleted, then press the button to bring up the **Setting display menu**. Delete the selected file, referring to **How to use the menu** [p.52](#) and the **PC card setting menu** [p.54](#).

Using the document camera

Please read this chapter if the model you purchased includes a document camera.

■ Preparation of the document camera

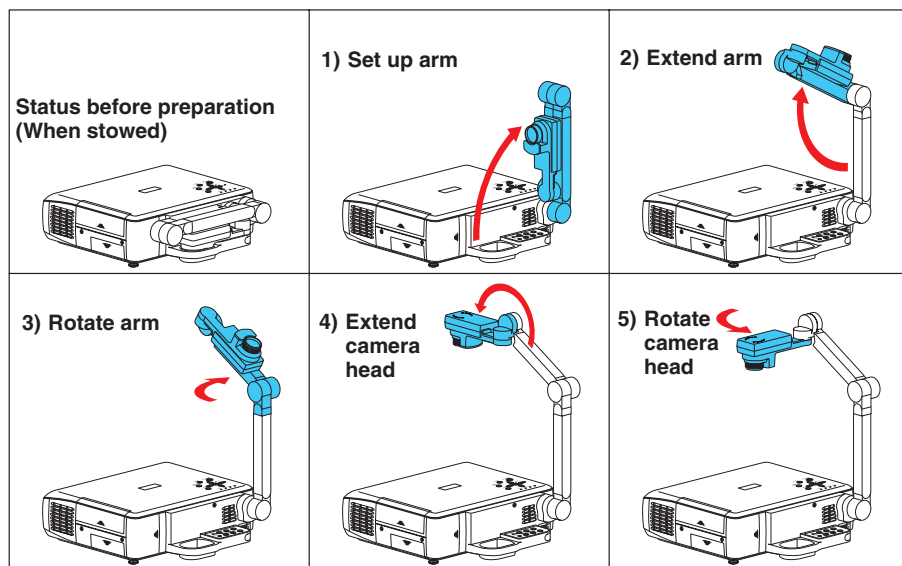

■ PRECAUTIONS

- Do not jolt or force the camera head or camera arm. Doing so could cause malfunction.
- Note that when extending or rotating the camera arm, the arm moves in an arc. Take care not to bump yourself or others with it.

■ Image projection with the document camera

① Press the ARM LIGHT button.

The arm light comes on. (Press it again to turn off the light. Use the light as needed, depending on the indoor lighting conditions.)

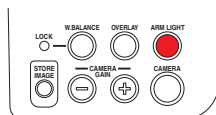

② Set up document to be photographed.

Place the document or other material on or near the camera, and point the camera head at it.

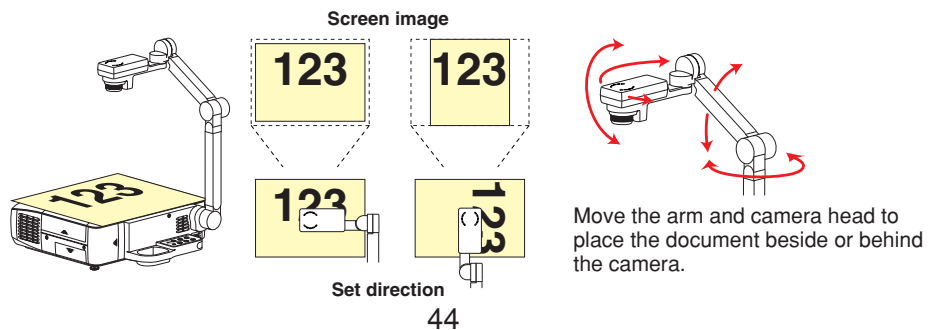

③ Press the CAMERA button, and select camera input.

- The input returns to the previous input when the CAMERA button is pressed again.
- Camera input can also be selected by pressing the remote control or camera's INPUT button.

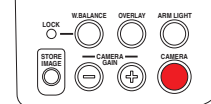

④ Move the camera head up and down to adjust the image size.

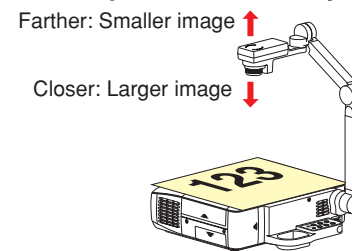

⑤ Use the camera head's focusing ring to adjust the focus.

Turn the focusing ring to adjust the focus.



⑥ If the screen is too dark or too bright, use the CAMERA GAIN (+/-) buttons to make it easier to see.

The Sharpness of the camera image can also be adjusted using the **Image adjustment menu** [p.53](#).

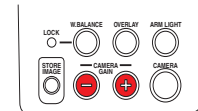

⑦ After use, turn off the light, and fold up the document camera.

Fold up the camera using the opposite order from **Preparation of the document camera**.

■ PRECAUTION

- If the room's fluorescent lighting causes the image to flicker, either turn off the fluorescent light, or set the **Shutter speed** from the **Auto setting menu** [p.29](#). Note that changing the **Shutter speed** setting may not eliminate the flicker, depending on the lighting, state of the document, or image adjustment.
- When arm light is used, document camera image of paper/object with reflective surface may have bright spots. In this case, turn off the arm light and have an adequate lighting from the room light.

■ Notes

- The camera light automatically goes off when the camera arm is collapsed.
- The camera will not output images when the camera arm is stowed.
- No audio is output when camera input is selected.

Using the document camera (Continued)

■ Using the overlay function

The overlay function can be used to write over computer or video input images. Have a piece of white paper, and a red or blue pen ready.

- 1 Place the piece of white paper on a flat surface, photograph it with the document camera, and display it on the screen.

Adjust the camera head and arm so that the white paper fills the screen.

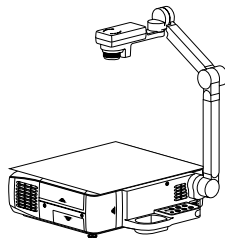

- 2 Select the input that the overlay function is performed.

Press the INPUT button, use the \blacktriangle \blacktriangledown buttons to select an input other than Camera input, then press the \odot button.

- 3 Press the OVERLAY button.

The overlay function comes on.
(Press it again to turn off the function.)

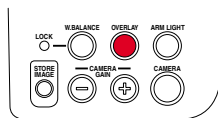

- 4 Write on the paper with a red or blue pen.

Before writing, check the position of the pen tip on the screen. The line written overlays the input source's image on the screen.

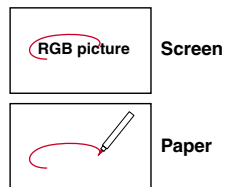

- 5 Use the CAMERA GAIN (+/-) button to adjust the lines or text so that it is easiest to see.

■ Notes

- The writing will not be displayed properly if using colors other than blue or red.
- The writing may not be displayed properly if the pen is too fine.

■ Locking the white balance

Although the projector's camera is constantly adjusting the color balance of the images it photographs, the color balance may be disrupted, depending on the color layout of the document, etc. If this happens, the white balance can be locked using the procedure below.

- 1 Lay down a piece of white paper, and adjust so it fills the screen.

Adjust the camera head and arm so that the white paper fills the screen completely.

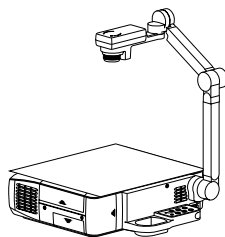

- 2 Press the W.BALANCE button. The LOCK indicator lights. Lit

The white balance is locked.

The white balance returns to automatic adjustment when pressing the W.BALANCE button again. Then LOCK indicator goes out.

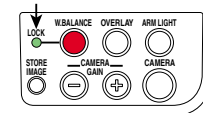

■ Notes

- When the white balance is locked (the LOCK indicator is lit), folding and extending the arm will automatically return to automatic adjustment.
- The color of the room lighting may prevent the white balance from being adjusted to the optimum level. In this situation, or if you want to use a certain tinting, adjust the R-level, G-level, and B-level on the Image adjustment menu [p.53](#).

■ Correcting illuminated defects

In rare cases, a portion of the pixels of CCD image sensor used by the camera could be damaged by cosmic rays and the like. This damage could cause white spots (illuminated defects) to appear on the screen. If illuminated defects appear in the images of the document camera, correct them as follows:

- 1 With the document camera in use, cover the camera lens completely with black paper, cloth, or the like.

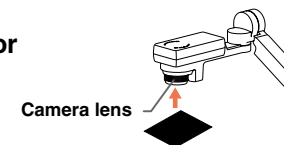

- 2 Press the ARM LIGHT button on the Camera control panel and the \odot button on the control panel (main unit side) simultaneously. (The remote control \odot buttons cannot be used.)
The illuminated defects are corrected.

■ PRECAUTION

- Do not press both the ARM LIGHT button and \odot button when the camera lens is not blocked. Doing so will erase correction data that has already been stored, or add corrections to normal areas. This should also take care when camera input is not selected.

Using the document camera (Continued)

■ Sending the camera's images to a computer (Models equipped with PC card slot)

Models equipped with a PC card slot can use a wireless LAN PC card to send images taken with the document camera to a computer in JPEG format, and open them, or save them to disk.

❶ Preparing the computer and projector

- Mount the supplied wireless LAN PC card referring to “Mounting a PC card” p.23 , and select PC card input in accordance with “Select input” p.27 .
- Set up the computer and projector in accordance with “Preparation” p.34 , and enable wireless LAN communication.

❷ Operating the projector

❶ Switch to camera input.

❷ Display the camera image, and press the STORE IMAGE button.

A message appears on the screen, confirming that you wish to save the image.

❸ Press the button to save the image.

(To not save the image, use the   buttons to select No, then press the  button.)

The image data is temporarily saved in the projector as a JPEG file.

When the save is complete a message appears, then disappears after a moment.

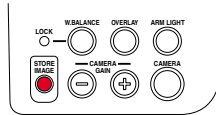

❸ Operating the computer

❶ Launch the Wireless Utility software application.

❷ Click on the Document camera icon .

The Wireless Utility window changes to Document camera mode.

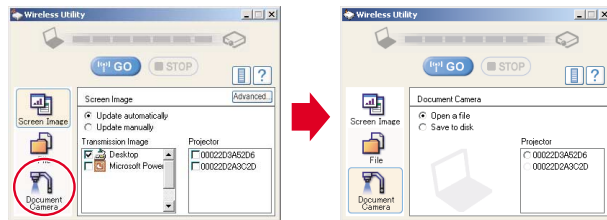

❸ Select Open a file or Save to Disk.

If you only want to view the image taken with the document camera on the computer screen, select **Open a file**.

To save the JPEG file sent from the projector to disk, select **Save to Disk**.

❹ Select the projector on which the images were temporarily saved in step ❷.

A list of the MAC addresses of the wireless LAN PC cards p.32 , p.59 mounted on the projectors that are available for communication appears. (If projector name has been set up already, it is shown instead of the MAC address.) Select the desired projector from this list.

Then icon  is displayed on the projector's screen for few seconds.

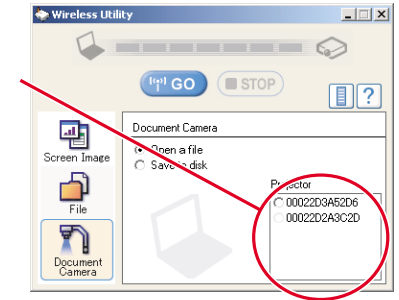

❺ Click on the button.

If Open a file was selected in step ❸

Open the JPEG file sent from the projector, and display it on the computer. The software application linked to the jpg extension on that computer displays the file.

If Save to Disk was selected in step ❸

A dialog box appears, prompting you to select a location in which to save the JPEG file sent from the projector. Specify a file name in this dialog box to save the file.

To view or save another image from the camera, repeat ❷ and ❸ of step ❷, and ❺ of step ❸ as many times as necessary.

■ Notes

- Only one image can be saved on this projector temporarily at a time. If another image is saved, the current one is overwritten.
- Any adjustments other than **CAMERA GAIN (+/-)** and **Sharpness** will not be reflected on the forwarded image.
- It is not possible to photograph **resized** or **frozen** images.
- The size of the saved file will vary, depending on the image.

Using the document camera (Continued)

■ Storing the camera images into the memory PC card (Models equipped with PC card slot)

Models equipped with a PC card slot are able to save image data taken with the document camera onto a memory PC card (sold separately) in JPEG format.

1 Mount a memory PC card into the PC card slot [p.23](#).

Mounting a PC card will switch to PC card input if **Input select mode** is set to **Auto** on the **PC card setting menu** [p.54](#). In this case, press the CAMERA button on the Camera control panel to switch to camera input.

2 Display the camera image, and press the STORE IMAGE button.

A message appears on the screen, confirming that you wish to save the image.

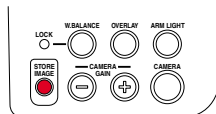

3 Press the buttons to save the image.

(To not save the image, use the buttons to select No, then press the button.) Data save to the memory PC card begins.

The icon will appear on the upper left of the screen during saving.

Never remove the memory PC card during a save. Doing so could corrupt your data, or damage the PC card.

When the writing is complete, the icon disappears and a message appears informing you that saving is complete, then disappears after a few seconds.

Repeat step 2 3 as necessary to store more images.

4 Check the saved file, if necessary.

Use the steps in “Projecting images stored in a memory PC card” [p.41](#) to check the contents of the file or image. Images are saved in the memory PC card’s _doccam folder in JPEG format. If there is no _doccam folder, the images are created in the memory PC card’s root directory.

■ Notes

- Any adjustments other than **CAMERA GAIN (+/-)** and **Sharpness** will not be reflected on a JPEG file saved on the memory PC card.
- It is not possible to photograph **resized** or **frozen** images.
- Saved files are saved with names in the range of pix001.jpg to pix999.jpg. If there is already a file named pix999.jpg, no more files can be saved.
- The size of the file will vary, depending on the image. The number of files that can be saved depends on the size of the files and the capacity of the memory PC card.
- Do not mount a write-protected memory PC card into the projector. It may become impossible to access the memory PC card.

Operating a computer using the remote control

A computer can be operated using the projector’s remote control. This function is available on any computer with the Windows 98/98SE, Windows Me, Windows 2000, or Windows XP OS, that is equipped with a USB port (The mouse remote control is not supported on OS 9 or OS X for the Macintosh).

1 Connecting a computer

Connect the projector to a computer using the supplied USB cable. See Fig. (1) below. For models equipped with PC card slot, connect the supplied Mouse remote control receiver to the computer. See Fig. (2) below.

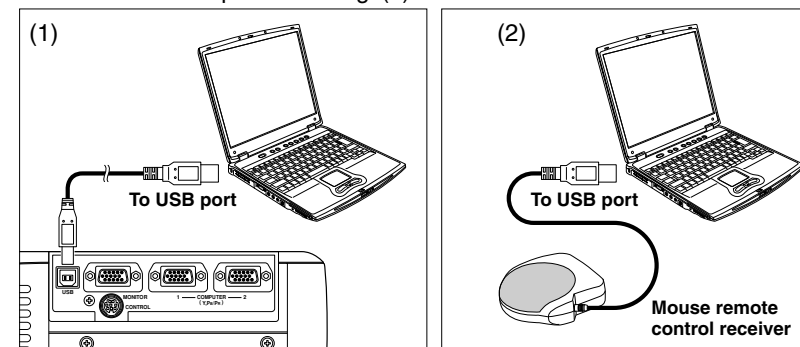

2 Operating a computer

The mouse remote control function is available when the remote control is set to [PC Mode]. (See “Switching operation modes” [p.20](#).)

Point the remote control at the infrared remote sensor (in models using Mouse remote control receivers, point it at the Mouse remote control receiver), and operate the remote control’s buttons.

● Moving the mouse pointer

Move the pointer control button in the direction that you wish the mouse pointer to move, then press.

● To left click

Press the L-CLICK button.

● To right click

Press the R-CLICK button.

● To drag and drop

Move the pointer control button in a (L-)clicked state, then when the pointer is over the desired location, release the button.

● Using the computer’s up and down arrow key functions

Press the and buttons to switch PowerPoint® slides.

Remote Control Front Remote Control Rear

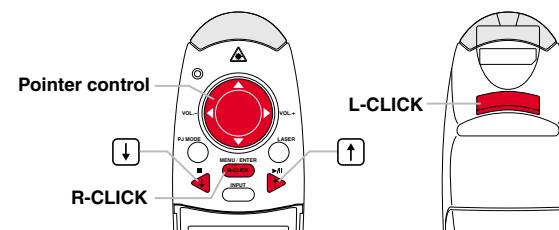

Using the menus

You can call up on-screen menus, and conduct a number of adjustments and settings, using the operation buttons [p.16](#) on the control panel (main unit side) and remote control.

How to use the menus

The menu shown below is only for operation instructions and might be different from the actual display.

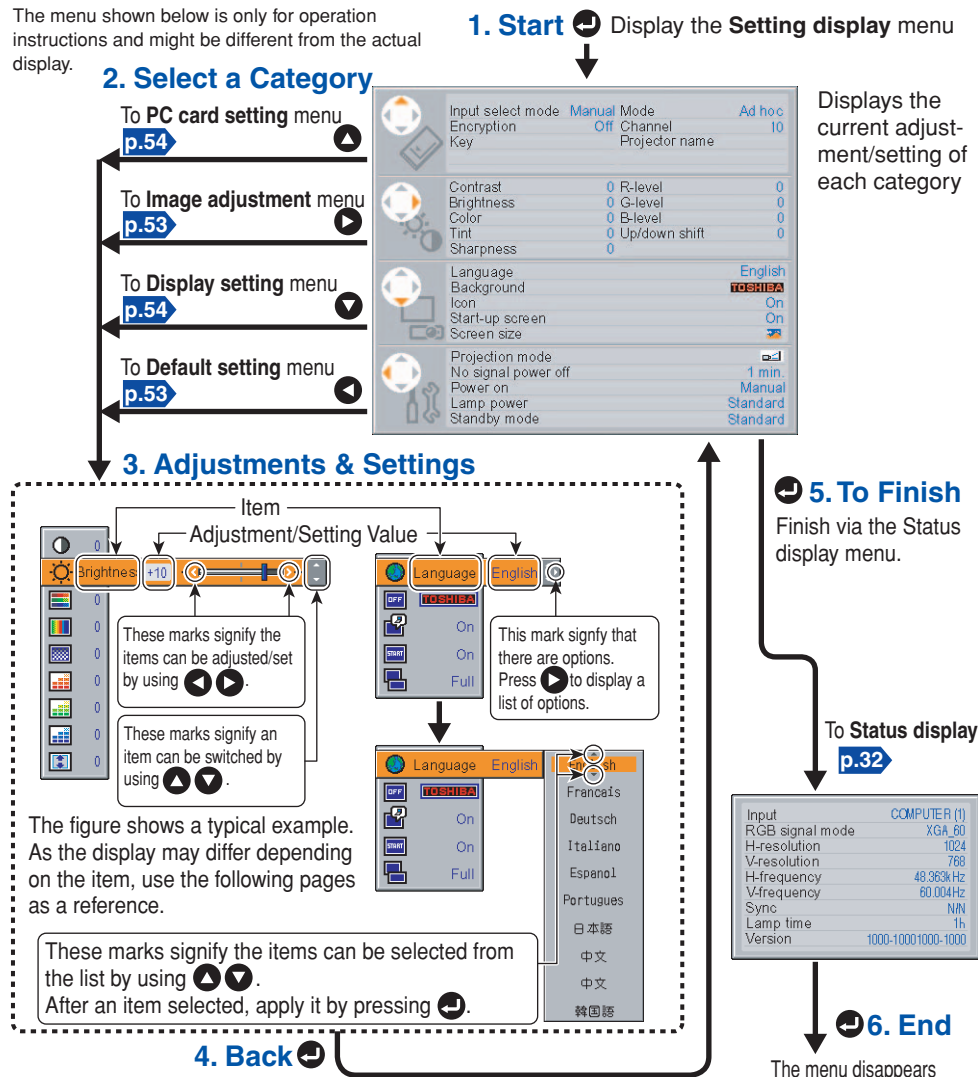

Note

- Menu adjustments and settings (except Lamp power [p.53](#)) are saved when the power is turned off via the ON/STANDBY button. If the power cord is unplugged before this, or the power goes out, then the data will not be saved.

The image adjustment menu

Use this menu to adjust image-related items.

Items that can be adjusted are marked with “Yes”, and those that cannot are marked with “No”.

Item	Description	Computer	Y/PB/PR	Video S-video	PC Card	Camera
Contrast	Lower Higher	Yes	Yes	Yes	Yes	Yes
Brightness	Darker Brighter	Yes	Yes	Yes	Yes	Yes
Color	Lighter Deeper	No	Yes	Yes	No	No
Tint [Note 1]	Reddish Greenish	No	No	Yes	No	No
Sharpness	Softer Sharper	No	Yes	Yes	No	Yes
R-level	Less red More red	Yes	Yes	Yes	Yes	Yes
G-level	Less green More green	Yes	Yes	Yes	Yes	Yes
B-level	Less blue More blue	Yes	Yes	Yes	Yes	Yes
Up/down shift [Note 2]	Shift down Shift up	No	Yes	Yes	No	No

Notes

- Tint** can only be adjusted when **Video mode** [p.29](#) is **NTSC** or **NTSC4.43**.
- Up/down shift** can only be adjusted when **Screen size** [p.54](#) is **Wide**.

The default setting menu

This menu shows placement status and other settings.

Item	Description
Projection mode	Set projection mode in accordance with Placement Style p.21 (Placed on floor) (Rear) (Hung from ceiling) (Back hung from ceiling)
No signal power off	Set the time to wait after signal input stops until turning off the power: Off (not turned off) 1 min 2 min 60 min
Power on	Set whether to turn on the power when the ON/STANDBY button is pressed (Manual), or when the power cord is plugged in (Auto). Manual Auto
Lamp power [Note 1]	Set the lamp power Standard Low
Standby mode [Note 2]	Set standby mode according to functions used Standard Economy

Notes

- When **lamp power** is set to **low**, the screen becomes a little darker, but the cooling fan noise gets quieter. This setting will be cleared when you turn the power off. The setting will be back to “Standard” when the power is turned on next time.
- The **Standby mode** function is only available with models equipped with a PC card slot [p.39](#).

Notes

- Note that if **Power on** is set to **Auto**, then if the power cord is plugged in when power is restored after a power outage, the projector power will come on.
- Even if **Power on** is set to **Auto**, press the **ON/STANDBY** button to turn off the power. Unplugging the power cord to cut off the power will shorten the life of the lamp.

Using the menu (Continued)

■ The display setting menu

Use this menu to set screen display-related items.

Item ▲▼	Description
Screen size Not displayed with PC card input or camera input.	 (Full): Display with LCD panel's resolution (Thru): Display with sampling resolution (for computer input) (Wide): Wide-screen display (for Video, S-video, and Y/P _B /P _R)
Language	Select one of the languages below to use for displaying menus and messages [Enter setting mode] → [Selection] → [Apply:] English/Français/Deutsch/Italiano/Español/ Português/ 日本語 / 中文(简体字) / 中文(繁体字) / 한국어
Background	Screen to display when there is no input signal (Logo) (Blue) (None)
Icon	Display icons as function guides On Off
Start-up screen	Display start-up screen when power turned on On Off

■ Note

- If "Thru" is selected for **screen size**, portions exceeding the pixel count of the LCD panel [p.67](#) will not appear on the screen. Note that for RGB signals with clock speeds UXGA 60 [p.68](#) or lower, all input pixel signals are sampled. (This effect is noticeable when the screen is enlarged using the Resize function [p.31](#)). However, if the clock speed is higher than this, the RGB pixel signal is thinned before sampling.

■ The PC card setting menu (Models equipped with PC card slot)

Use this menu to set PC Card-related items.

● When using a memory PC card

Item ▲▼	Description
Input select mode	Manual Auto (Switch to PC card input when a PC card is inserted)
Auto. Demo	Off On (Begin slid show when PC card is inserted)
Interval	Select one of the following slide show display intervals: 5 sec./10 sec./30 sec./1 min./3 min./5 min./10 min.
File deletion	Delete the selected file (Folders cannot be deleted) [Enter execution mode] → [Yes No] → [Apply:]

● When the wireless LAN PC card is being used

Item ▲▼	Description
Input select mode	Manual Auto (Switch to PC card input when the PC card is inserted)
Transmission mode	Ad hoc Infrastructure
Channel	This item cannot be changed currently. This is function for the future.
Encryption	[Enter setting mode] → [Selection] → [Apply:] Off 64bit 128bit
Key	Set the desired string (5 or 13 characters) [Enter setting mode] → [Shift column] ↔ [Set character] → [Apply:]
Projection name	Set the desired string (1 to 14 characters) [Enter setting mode] → [Shift column] ↔ [Set character] → [Apply:]
Setting initialization	Return the wireless LAN configuration to the default settings [Enter setting mode] → [Yes No] → [Apply:]

■ Note

- Wireless LAN settings are enabled after the menu disappears.

■ Reset menu (Special menu)

This menu is displayed when other menus are not displayed, and the button is held down until the menu appears.

- When the screen is placed vertically, and **Auto keystone correction** is executed, but the keystone correction is not successful, stow the foot adjuster in its original position, place the projector on a flat surface, select **Horizontal reference value reset**, and press the button.
- Select **Reset All** and press the button to return all menu items to the factory settings.

Item ▲▼	Description
Horizontal reference value reset	Reset the horizontal reference value for Auto keystone correction [Enter execution mode] → [Yes No] → [Apply:]
Reset all	Reset all menu items to their factory settings [Enter execution mode] → [Yes No] → [Apply:]

Air filter cleaning

The air filter prevents dust and debris from getting inside the projector. Never run the projector with the filter removed. It is recommended that the air filter is cleaned regularly. (A recommended measure is about once for every 50 hours of use.)

⚠ CAUTION

- Request cleaning and maintenance of a ceiling-mounted unit from your projector dealership.

1 Unplug power cord.

2 Remove the air filter cover.

Of the upper connection terminal cover is on, remove that first.
Remove the air filter cover by pressing on the part in the figure with your finger.

3 Remove the air filter.

Remove the air filter from the air filter cover. It can be disassembled into the air filter cover, air filter, and filter holder.

4 Clean the filter.

Carefully remove the dust and dirt from the air filter cover, air filter, and filter holder with a vacuum cleaner or the like. Be careful not to let the air filter be sucked into the vacuum cleaner.

5 Assemble the air filter.

Insert the air filter into the air filter cover, and lock it in place by putting the pegs of the filter holder through the holes in the air filter cover.

6 Replace the air filter cover.

■ Notes

- Allowing dirt and dust to build up on the air filter will worsen the air circulation inside the projector, causing the internal temperature to rise, causing the projector to stop working or malfunction.
- Insert the air filter cover all the way in. Leaving gaps will allow dust and dirt to get inside the projector.
- If you wash the air filter with water, make sure to dry it completely before replacing it.
- If the air filter is torn, consult with your dealer about replacing it with a new one. Continuing to use a ripped filter will allow dust and dirt to get inside the projector.

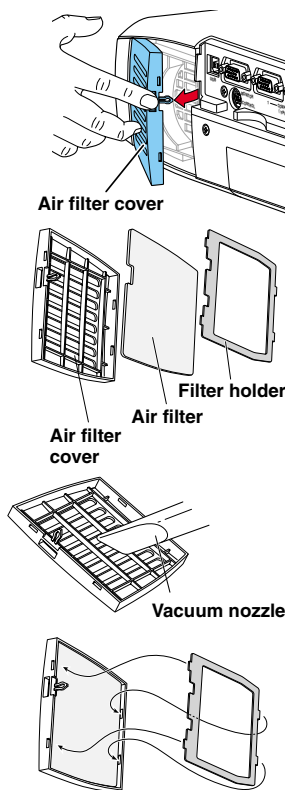

Lens and main unit cleaning

■ Lens cleaning

- Clean the lens with a commercially available blower and/or lens cleaner.
- The lens is easily scratched, so do not rub it with hard objects, or strike it.

■ Main unit cleaning

- Clean the main unit after unplugging the power cord.
- Wipe dirt off the main unit gently with a soft cloth.
- If the soiling is severe, dip the cloth in a neutral detergent diluted in water, wring well, and gently wipe off the dirt, then finish up by wiping with a dry cloth.

● Replacing air intake and exhaust fans, and air filter

To maintain the performance, it is recommended that these should be replaced about every 2 to 3 years. Consult with your dealer for details.

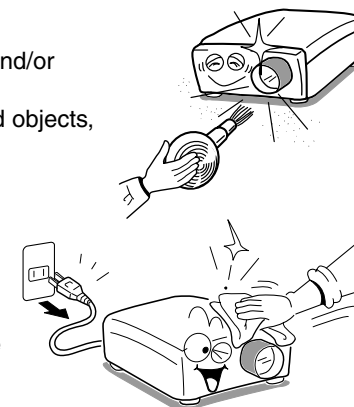

Lamp replacement

A lamp is consumable supplies. If used for extended periods, images will appear dark, and the lamp could burn out. This is characteristic of a lamp, and is not malfunction. (The lifetime of the lamp depends on conditions of use.) If this happens, replace it with a new one.

⚠ CAUTION

- Request cleaning and maintenance of a ceiling-mounted unit from your projector dealership.
- When replacing, always use lamp “TLPLW1” (sold separately).
- If you have been using the projector, the lamp will be very hot, and may cause burn injuries. Wait for the lamp to cool (for longer than 1 hour) before replacing it.
- If the lamp should break, please handle with care to avoid injury due to broken pieces and contact your dealer for repair service.

1 Unplug power cord.

2 Wait until lamp is sufficiently cooled.

Wait for at least 1 hour.

Lamp replacement (Continued)

3 Remove the lamp cover.

Loosen the screws, then pull up to direction of the arrow with your fingers on the area shown in the figure to remove the lamp cover. Be careful to avoid breaking a nail or otherwise injuring your fingers when doing so. (If the screws are too tight to remove the lamp cover, use any tool.)

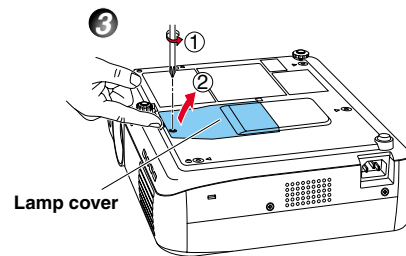

4 Pull out the lamp.

Loosen the 2 screws holding the lamp in place, and pull on the handle to remove the lamp.

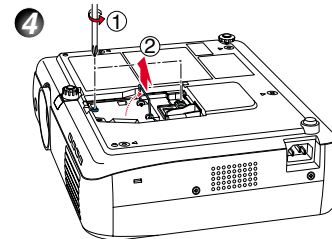

5 Mount the new lamp.

Align the orientation, press down until the bottom is reached, and lock in place using the two lamp locking screws.

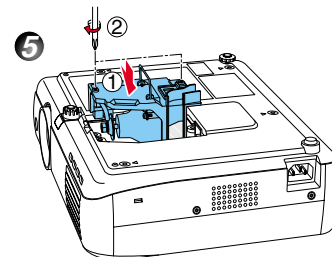

6 Replace the lamp cover.

Align the cover, and press it in, then screw in the screws loosened in step 3 until the lamp cover is no longer loose.

7 Reset the lamp timer.

See the lamp's manual for instructions on resetting the lamp timer.

Notes and Precautions

- Press the button twice to display (a rough guide) of the time of use from the **Lamp time** item on the **Status display menu**. [p.32](#)
- As a rule of thumb, it is recommended that the lamp should be replaced after 2,000 hours of use. When **Lamp time** reaches 2,000 hours, the icon and a message will appear. When any operation is performed, the message disappears.
- Attach the lamp cover correctly so that it is not loose. If it is not attached correctly, the lamp may fail to come on [p.64](#), and the lamp's lifetime may be shortened.
- Always replace the lamp with a new one.
- The lamp is made out of glass. Do not touch the glass surface with your bare hands, bang it, or scratch it. (Dirt, jolts, scratches and the like could break the lamp.)

Used Lamps

This projector's lamps contain trace amounts of environmentally harmful inorganic mercury. Be careful not to break used lamps, and dispose it in accordance with local regulations.

How to use the supplied software

Please read this chapter if the model you purchased includes a PC card slot.

This chapter briefly describes how to use supplied software applications other than the Wireless utility.

How to use the Projector Configuration Tool

The **Projector Configuration Tool** is a software utility that allows you to set up the projector for Infrastructure mode communications using a wireless LAN PC card. When using this application for the first time, conduct **Preparation** [p.34](#), and start with the computer in Ad hoc transmission mode.

1 Check MAC address.

The MAC address is a unique address assigned to the wireless LAN PC card. Display the **MAC address** on the screen, referring to "**Displaying Information**" [p.32](#). Note down the address for future use.

2 Launch the Projector Configuration Tool.

Upon launch, the window shown in the figure to the right appears on the computer screen.

3 Click on the Browse button.

The computer starts searching for projectors. When it finds one, "**Please select**" is displayed in the **Projector Selection** field.

4 Select a projector.

Click on the button for the **Projector Selection** field, then from the pull-down list that is displayed, select the project with the MAC address you noted down in step 1.

When a projector is selected, the computer obtains information from that projector, and displays the results in the boxes of the window.

Here, the following is possible:

From the **File** menu, select **Save As...**, and save the pre-modification settings on the computer.

From the **File** menu, select **Open**, and apply an existing settings file to the projector.

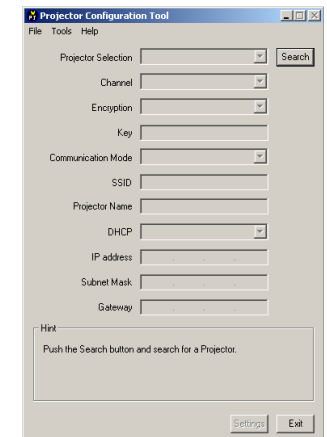

How to use the supplied software (Continued)

5 Configure the projector.

[Channel]

This item cannot be changed currently.

[Encryption]

Click on the  button to select [Off], [64 bit], or [128 bit].

[Key]

This accepts input if **Encryption** is set to other than **Off** (input is required). Input a value from the keyboard.

[Communication mode]

Select **Infrastructure** by clicking the  button.

[SSID]

This is an ID code for connecting to specific individuals over a wireless LAN. This field accepts input when set to Infrastructure Transmission Mode. Set the SSID to the same value as the access point. In factory shipment, this is set to DPJ.

[Projector name]

It is recommended this is set to prevent wrong transmission. [p.34](#)

[DHCP]

Specify by clicking the  button. If this is set to **Used**, the **IP Address**, **Subnet Mask**, and **Gateway** below are set automatically.

Consult with a network administrator for the settings below, if **DHCP** is not used.

[IP Address]

An IP (Internet Protocol) is a data communication protocol. The delivery destination is an IP address.

[Subnet Mask]

This value is to set a limit on the range of IP addresses, and set up a number of sub-networks.

[Gateway]

This is a relay point for connecting different types of network.

6 Press the Settings button.

Communication begins, and the computer configures the projector. When setup is finished, a message appears in the window telling you that setup is complete.

From the **File** menu, select **Save As...**, and save the settings file on the computer.

How to use the JPEG Conversion Tool

The **JPEG Conversion Tool** converts JPEG files not supported by the projector, image files in other formats, Microsoft® PowerPoint® files, and the like into JPEG files supported by the projector. The JPEG files converted with this tool can be displayed by sending them using the wireless LAN PC card [p.37](#), or saving them on a memory PC card [p.41](#).

● Launching the JPEG Conversion Tool

The window shown in the figure to the right appears on the computer screen.

Drag the **Image Quality Settings** slider to the left or right to set the image quality of the file after conversion. Lower values create smaller files, but lower the image quality. (It is not possible to restore the quality of an image after it has been lowered.)

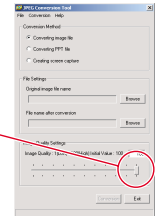

● Converting an image file

This converts JPEG files using compression formats not supported by the projector, Windows® metafiles (wmf), and bitmapped files (bmp) into JPEG files.

(1) In the **Conversion Method** field, select **Converting image file**. (Status on launch)

(2) In the **File settings** field, click on the **Browse** button for **Original Image File Name**.

The **Open** dialog box appears.

(3) In the **Open** dialog box:

(a) Specify the **location of the file** to be converted; and

(b) In the **Files of Type** field, click on the  button to select the file format. A list of files of that format appear in the **Open** dialog box.

(4) In the **Open** dialog box, select the file to convert, then click on the **Open** button.

(5) In the **JPEG Conversion Tool** window, in the **File settings** field, select **Browse** for **File name after conversion**. The **Save As** dialog box appears.

(6) In the **Save As** dialog box:

(a) Specify the **location** in which to save the converted file;

(b) Enter a file name of up to 8 characters in the **File Name** field; and

(c) Press the **Save** button.

(7) (a) In the **JPEG Conversion Tool**, click on the **Conversion** button.

(b) A confirmation dialog box opens. Click **Yes**.

The computer converts the file. When it finishes a message appears informing you that a **JPEG file has been created**.

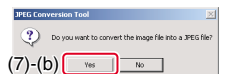
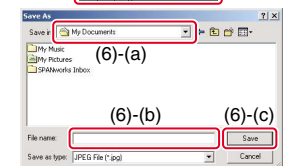
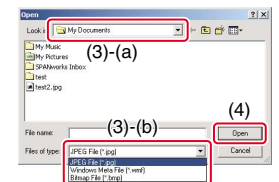
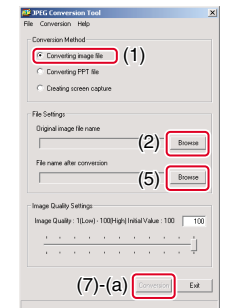

How to use the supplied software (Continued)

● Converting files created with Microsoft® PowerPoint®

This process provides presentations without using a computer by converting presentation files created with Microsoft® PowerPoint® into JPEG files, storing them on a memory PC card, and displaying them in a slide show.

- To use this conversion mode, Microsoft® PowerPoint® must be installed on the computer.
- Only static images are supported by this process. Animation and audio are not supported.

Presentation files created with Microsoft® PowerPoint® usually consist of several slides. For this reason, the tool creates a folder with the name specified in step (5), below, and file for each slide is created in the folder (starting with slide001.jpg).

(1) In the **Conversion Method** field, select **Converting PPT file**.

(2) In the **File settings** field, click on the **Browse** button for **PPT File Name**.

The **Open** dialog box appears.

(3) In the **Open** dialog box:

(a) Specify the **location of the file** to be converted; and

(b) Select the PowerPoint® presentation file to convert, then click on the **Open** button.

(4) In the **JPEG Conversion Tool** window, in the **File settings** field, click on the **Create** button for **New folder name**.

The **Folder create** dialog box appears.

(5) In the **Folder create** dialog box, in the **Folder Name** of document field, specify a folder name of 12 characters or less.

(6) In the **Folder create** dialog box, click on the **Selection** button.

The **Browse Folders** dialog box appears.

(7) In the **Browse Folders** dialog box:

(a) Specify the location in which to save the folder; and

(b) Click on the **OK** button.

(8) In the **Folder create** dialog box:

(a) Click on the **Create** button.

A confirmation dialog box appears;

(b) Click on the **OK** button.



(9) (a) In the **JPEG Conversion Tool** window, click on the **Conversion** button.

(b) A confirmation dialog box opens. Click **Yes**.

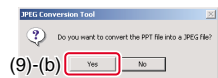
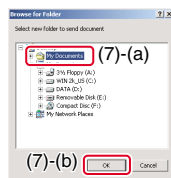
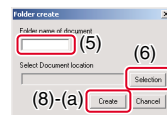
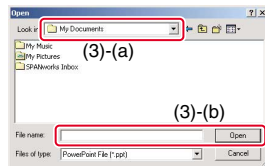
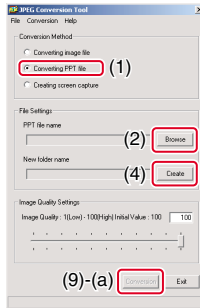
The computer begins to convert the file. When it finishes, a message appears informing you that a **JPEG file has been created**.



■ Making a presentation with converted JPEG files

- 1) Copy the folder created by the **JPEG Conversion Tool**, or its contents, onto a memory PC card.
- 2) Use the steps ①, ② in “**Projecting images stored in a memory PC card**” p.41 to display a list of thumbnails.
- 3) Follow the instructions in step ③ to find slide001.jpg (the first slide), and move the orange frame over it (select slide001.jpg).
- 4) Set the remote control to [PJ Mode], and press the  button. An enlarged view of the first slide appears on the screen. This starts the presentation.
- 5) To continue to the next slide, click on the remote control's  button. To go back to the previous slide, click on the  button.

● Creating a screen capture and converting it into a JPEG file

This function saves the current computer screen as a JPEG file.

(1) In the **Conversion Method** field, select **Creating screen capture**.

(2) In the **File settings** field, click on the **Browse** button for **File name after conversion**.

The **Save As** dialog box appears.

(3) In the **Save As** dialog box:

(a) Specify the **location** in which to save the converted file;

(b) Enter a file name of up to 8 characters in the **File Name** field; and

(c) Click on the **Save** button.

(4) (a) In the **JPEG Conversion Tool** window, click on the **Conversion** button.

(b) A confirmation message appears. Click **Yes**. The computer creates a screen capture, and converts it into a JPEG file in the specified location. When it is finished, a message appears to tell you that a **JPEG file has been created**.

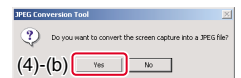
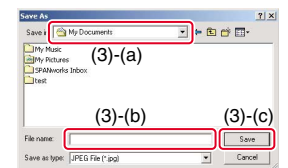
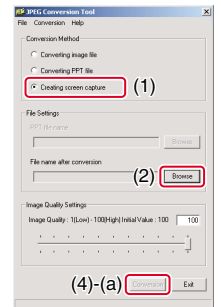

■ Note

- The maximum resolution of JPEG files created with the **JPEG Conversion Tool** is 1,024 x 768 pixels.

Trouble indications

The indicator lights inform you of internal abnormalities.

	<p>No power</p> <p>⇒ Problem with projector</p> <ul style="list-style-type: none"> Unplug the power cord, and contact your dealer.
	<p>Lamp went out during use, or won't come on</p> <p>⇒ Returns to standby after about 2 minutes. If the projector fails to operate normally after turning the power back on, either the lamp needs replacing, or there is a problem with the projector.</p> <ul style="list-style-type: none"> If a lamp burns out, replace it with a new one. Unplug the power cord, and contact your dealer.
	<p>Power went out during use, or power won't come on</p> <p>⇒ Internal overheating, or the outside temperature is too high.</p> <ul style="list-style-type: none"> Place the projector so that the air intake and exhaust are not blocked. Unplug the power cord and wait for a short while, then turn the power back on. Clean the air filter. p.56 <p>* The icon will appear before the power goes out.</p> <p>* After displaying the abnormal state for about 2 minutes, returns to standby.</p>
	<p>Power went out during use, or power won't come on</p> <p>⇒ Problem with internal cooling fan.</p> <ul style="list-style-type: none"> Unplug the power cord, and contact your dealer. <p>* The icon will appear before the power goes out.</p> <p>* After displaying the abnormal state for about 2 minutes, returns to standby.</p>
	<p>Power went out during use, or power won't come on</p> <p>⇒ The lamp cover is not properly attached.</p> <ul style="list-style-type: none"> Unplug the power cord, and reattach the lamp cover. p.58 <p>* The icon will appear before the power goes out.</p> <p>* After displaying the abnormal state for about 2 minutes, returns to standby.</p>

PRECAUTIONS

- Make sure to unplug the power cord if something goes wrong.
- If the power cord is unplugged before cooling is complete, give the lamp time to cool before plugging it back in. If the lamp overheats it may fail to light. Unplugging the power cord repeatedly when the temperature is high will shorten the life of the lamp. (Even if you are not concerned about lamp lifetime, the light may not come on if you do not wait at least 3 minutes.)

Before calling service personnel

If you think something is wrong, check the following before contacting customer service. Please see "Trouble indications" [p.64](#) as well.

If This Happens	Check
<p>No power</p>	<ul style="list-style-type: none"> Is the power cord plugged in? Is it connected to the projector? Is the lamp cover loose? p.64
<p>Power goes out during use</p>	<ul style="list-style-type: none"> Is the ambient temperature high? p.64 Is the air filter clogged? p.64 Is the air intake or air exhaust blocked? p.64
<p>No picture</p>	<ul style="list-style-type: none"> Is the projector turned on? p.27 Is the mute function on? p.30 Is the brightness setting minimized? p.53 Are the connections set up correctly? p.22 Are all the connected devices functioning properly?
<p>No audio</p>	<ul style="list-style-type: none"> Is the projector turned on? p.27 Is the mute function on? p.30 Is the volume setting minimized? p.28 Are the connections set up correctly? p.22 Are all the connected devices functioning properly?
<p>Picture not displayed correctly</p>	<ul style="list-style-type: none"> Is the input signal supported by the projector? p.68, p.69 Is the correct video mode selected? p.29 Is the correct signal format selected? p.29 Is the selecting of RGB or Y/Pb/Pr input correct? p.27 Is there something generating an abnormal video signal, for instance the video tape?
<p>Picture blurred Part of picture out of focus</p>	<ul style="list-style-type: none"> Is the lens dirty? p.57 Is the lens focus adjusted optimally? p.28 Is the projection distance within the projector's supported range? p.21 Is the projector's screen placement angle tilted too far? p.21 Are the sharpness or sampling phase adjustments off? p.53, p.29
<p>Image is dark</p>	<ul style="list-style-type: none"> Are the brightness or contrast adjustments off? p.53 Is the lamp nearing the end of its service life? p.32
<p>Colors too light Bad shading</p>	<ul style="list-style-type: none"> Are the color, tint, R-level, G-level, or B-level adjustments off? p.53 Is the screen dirty? Is the lamp nearing the end of its service life? p.32
<p>Remote control doesn't work</p>	<ul style="list-style-type: none"> Are the remote control's batteries drained? Are the batteries inserted into the remote control correctly? p.19 Is the remote control being used within the effective range? p.19 Are there any obstructions between the remote control and projector? Is the correct operation mode set? p.20 Are there any fluorescent or other bright lights shining at the projector's infrared remote sensor?

Before calling service personnel (Continued)

If This Happens	Check
Mouse remote control doesn't work	<ul style="list-style-type: none"> Are the USB cable and mouse remote control receiver (Models equipped with PC card slot) correctly connected? p.51 Do your computer and OS support USB? Is the remote control in [PC Mode]? p.20 Are there any obstructions between the remote control and projector/mouse remote control receiver?
Memory PC card images aren't projected	<ul style="list-style-type: none"> Is the memory PC card inserted correctly? Is a PC card not supported by the projector inserted? p.40 Is the CARD indicator red? p.23 Are there any JPEG files saved on the memory PC card? Are the files too large or in an unsupported format for the projector? Convert them with the supplied software application. p.61
The wireless LAN PC card doesn't work	<ul style="list-style-type: none"> Is the wireless LAN PC card inserted correctly? Is a wireless LAN PC card not supported by the projector inserted? The operation of cards other than the supplied product is not guaranteed. Is the CARD indicator red? p.23 Are the transmission mode and channel properly configured? p.34 Are there any obstructions between the computer and projector? Do your computer and OS support the supplied software application? p.24
The images from the document camera are blurry	<ul style="list-style-type: none"> Is the document imaging camera's lens dirty? Is the document imaging camera out of focus? p.45 Is the location of the object being focused too dark?
The images from the document camera are flickering	<ul style="list-style-type: none"> Is there impact from the room's fluorescent lighting? Turn off the fluorescent lights, or change the shutter speed settings. p.29

Specifications

List of general specifications

Item	Specification	
Consumption Power	240 W	
Weight	TLP-T700/T500: 3.4 kg TLP-T600/T400/S200: 3.3 kg	
	TLP-T701/T501: 4.1 kg TLP-T601/T401/S201: 4.0 kg	
External Dimensions (including protruding parts)	Models without document imaging camera: 298 × 97 × 249 mm (W × H × D)	
	Models equipped with document imaging camera: 298 × 97 × 313 mm (W × H × D)	
Cabinet material*	PC+ABS resin and ABS resin	
Conditions for usage environment	Temp: 0°C to 35°C; relative humidity: 30% to 70%	
LCD Panel	Display method	3-panel transmission
	Panel size	0.9 inches
	Drive system	TFT active matrix
	Picture elements	TLP-T series: 786,432 pixels (1,024H × 768V) TLP-S series: 480,000 pixels (800H × 600V)
Lens	Zoom lens F=1.9-2.3 f=35.6-44.5 mm	
Lamp	High-pressure mercury lamp	
Projection screen size	32-300 inches	
Projection distance	1.50-11.74 m	
Speaker	1 W (Monaural)	
Connection terminal	COMPUTER-1,2 terminals	Mini D sub 15 pin RGB / Y/P _B /P _R (dual use)
	MONITOR terminal	Mini D sub 15 pin RGB / Y/P _B /P _R (dual use)
	S-VIDEO terminal	Mini DIN 4 pin
	VIDEO terminal	RCA Pin Jack, 1 V (p-p), 75 Ω
	AUDIO (L/R) terminal	RCA Pin Jack × 2, 1.5 V (rms); 22 kΩ or more
	AUDIO terminal	3.5mm dia. stereo mini-jack, 1.5V (rms); 22 kΩ or more
	CONTROL terminal	Mini DIN 8 pin (RS-232C)
USB terminal	Type B	
PC card slot	PC Card Standard TYPE II compliant (Models equipped with PC card slot)	

* Each plastic part displays the materials it is made from, in order to facilitate recycling after this product's use had ended.

Document camera specifications (Models equipped with document camera)

Item	Specification
Lens	F=2.8, f=3.4mm
Focusing	Manual operation
Zooming	None (adjusted through distance from subject)
Gain	Auto/manual
Image element	1/3 inch CCD
Effective pixels for pickup section	805,486 pixels (1,034H x 779V)
Lighting	LED

Specifications (Continued)

List of supported signals (RGB signals)

This projector supports the following RGB signals. Note, however, that depending on the computer model, the screen may show flicker or streaking. Please adjust the projector if this happens.

(Press the AUTO SET button, and adjust automatically or manually. [p.29](#))

Resolution	Mode	Refresh rate (Hz)	H-frequency (kHz)	Clock (MHz)
720 x 400	720x400_85	85.039	37.927	35.500
640 x 480	VGA_60	59.940	31.469	25.175
	VGA_72	72.809	37.861	31.500
	VGA_75	75.000	37.500	31.500
	VGA_85	85.008	43.269	36.000
800 x 600	SVGA_56	56.250	35.156	36.000
	SVGA_60	60.317	37.879	40.000
	SVGA_72	72.188	48.077	50.000
	SVGA_75	75.000	46.875	49.500
	SVGA_85	85.061	53.674	56.250
832 x 624	MAC16"	74.550	49.725	57.283
1024 x 768	XGA_43i	86.957	35.522	44.900
	XGA_60	60.004	48.363	65.000
	XGA_70	70.069	56.476	75.000
	XGA_75	75.029	60.023	78.750
	XGA_85	84.997	68.667	94.500
	MAC19"	74.700	60.134	79.857
1152 x 864	SXGA1_75	75.000	67.500	108.000
1280 x 960	QuadVGA_60	60.000	60.000	108.000
	QuadVGA_85	85.002	85.938	148.500
1280 x 1024	SXGA3_60	60.020	63.981	108.000
	SXGA3_75	75.025	79.976	135.000
	SXGA3_85	85.024	91.146	157.500
1400 x 1050	SXGA+	60.012	63.973	118.094
1600 x 1200	UXGA_60	60.000	75.000	162.000
	UXGA_65	65.000	81.250	175.500
	UXGA_70	70.000	87.500	189.000
	UXGA_75	75.000	93.750	202.500
UXGA_85	85.000	106.250	229.500	
1792 x 1344	1792x1344_60	60.000	83.640	204.750
1856 x 1392	1856x1392_60	60.000	86.333	218.250
1920 x 1440	1920x1440_60	60.000	90.000	234.000

Note

- Signals whose resolution exceeds the LCD panel's number of pixels [p.67](#) will be compressed. For this reason, some information may be lost, or image quality may be affected.

List of supported signals (Y/Pb/Pr signals)

Signal format	fh(kHz)	fv(Hz)
480i(525i)@60Hz	15.73	59.94
480p(525p)@60Hz	31.47	59.94
576i(625i)@50Hz	15.63	50.00
576p(625p)@50Hz	31.25	50.00
720p(750p)@60Hz	45.00	60.00
720p(750p)@50Hz	37.50	50.00
1080i(1125i)@60Hz	33.75	60.00
1080i(1125i)@50Hz	28.13	50.00
1035i(1125i)@60Hz	33.75	60.00
1152i(1250i)@50Hz	31.25	50.00

List of supported signals (Video, S-Video signals)

Video mode	fh(kHz)	fv(Hz)	fsc(MHz)
NTSC	15.73	60	3.58
PAL	15.63	50	4.43
SECAM	15.63	50	4.25 or 4.41
PAL-M	15.73	60	3.58
PAL-N	15.63	50	3.58
PAL-60	15.73	60	4.43
NTSC4.43	15.73	60	4.43

Pin assignment of COMPUTER-1/2 & MONITOR terminals

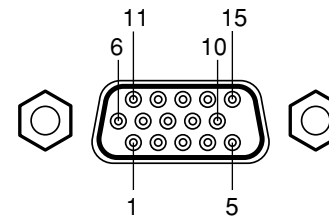

Mini D sub 15 Pin connector
Input Signal

- RGB input
 - R/G/B signals: 0.7V (p-p) 75 Ω
 - Horizontal sync signal: TTL level (Pos/neg polarity)
 - Vertical sync signal: TTL level (Pos/neg polarity)
- Y/Pb/Pr input
 - Y signal: 1.0V (p-p) 75 Ω
 - Pb/Pr signals: 0.7V (p-p) 75 Ω

Pin No.	Pin description	
	During RGB input	During Y/Pb/Pr input
1	Video signal (R)	Color difference signal (Pr)
2	Video signal (G)	Luminance signal (Y)
3	Video signal (B)	Color difference signal (Pb)
4	GND	*
5	GND	*
6	GND (R)	GND (Pr)
7	GND (G)	GND (Y)
8	GND (B)	GND (Pb)
9	N.C	*
10	GND	*
11	GND	*
12	N.C	*
13	Horizontal sync signal	*
14	Vertical sync signal	*
15	N.C	*

* Do not connect anything.

Specifications (Continued)

■ CONTROL terminal

● Pin assignment

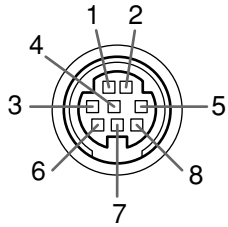

Mini DIN 8 pin connector

Pin No.	Signal Name	Description
1	RXD	Receiving data
2	CTS	Consent to send
3	DSR	Data set ready
4	GND	Signal ground
5	RTS	Request to send
6	N.C	No connection
7	TXD	Sending data
8	N.C	No connection

● Interface format

- 1 Communication method RS-232C, 9600bps, No Parity, Data Length: 8 bits;
Stop Bit Length: 1 bit
- 2 Communication format

STX (02h)	Command (3Byte)	ETX (03h)
-----------	-----------------	-----------

Only 1 command valid per communication.
- 3 Data format For input commands, only ASCII-compliant all-uppercase alphanumeric characters supported.
- 4 Replies Acknowledge

ACK (06h)

 No acknowledge

NAK (15h)

If commands are to be sent consecutively, wait for the response from the projector (ACK or NAK) before sending the next command.

● Main Commands

Item	Command	Item	Command
Power on	PON	Computer (1) input select	IN1
Power off	POF	Y/P _B /P _R (1) input select	IN2
OSD display on	MO0	Computer (2) input select	IN3
OSD display off	MO1	Y/P _B /P _R (2) input select	IN4
Auto setting (RGB input)	PAT	Video input select	IN5
Status display on	DON	S-video input select	IN6
Status display off	DOF	PC card input select	IN7
		Camera input select	IN8

■ Note

- Contact your dealer for control cable and other commands.

■ Separately Sold Product

Replacement Lamp Model TLPLW1

■ Note

- Design, specifications, etc. subject to change without notice for improvements, etc.

TOSHIBA CORPORATION

Others